

SUUNTO
X9

INSTRUCTION MANUAL

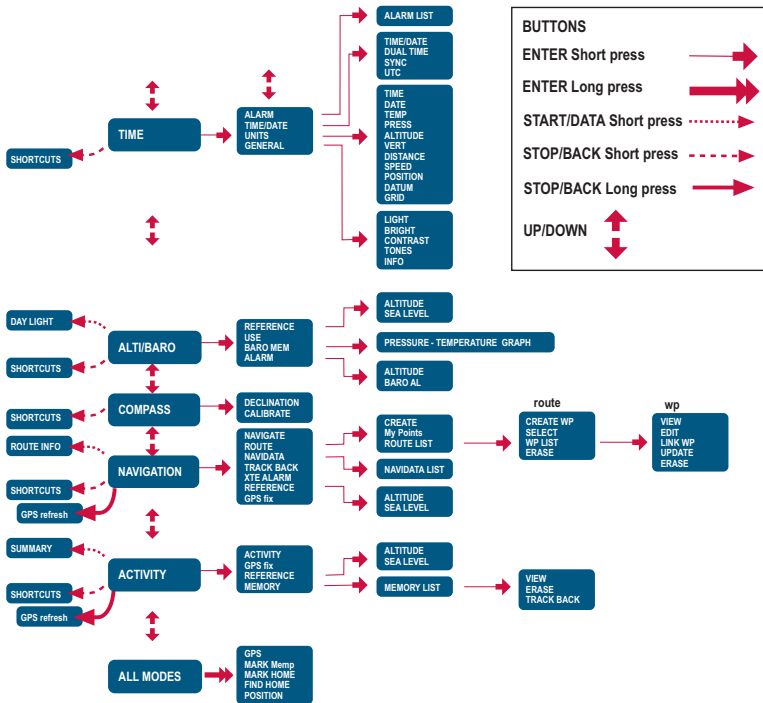

SUUNTO



CUSTOMER SERVICE CONTACTS

EN

Suunto Oy	Phone +358 9 875870
	Fax +358 9 87587301
Suunto USA	Phone 1 (800) 543-9124
Canada	Phone 1 (800) 776-7770
European Call Center	Phone +358 2 284 11 60
PC-related questions	softwarehelpdesk@suunto.com
Suunto Website	<u>www.suunto.com</u>

TABLE OF CONTENTS

1. GENERAL INFORMATION	6
1.1 CHECKLIST	6
1.2 CARE AND MAINTENANCE	6
1.3 WATER RESISTANCE	7
1.4 CHARGING THE BATTERY	7
2. HOW TO USE YOUR SUUNTO X9	10
2.1 DISPLAY AND BUTTONS	10
2.1.1 Mode indicator	10
2.1.2 Battery level Indicator	10
2.1.3 Alarm symbols	10
2.1.4 GPS reception indicator	10
2.2 MENUS	12
2.2.1 Basic menu structure	12
2.2.2 Press and long press	13
2.2.3 Navigating in the menus	13
3. MODES	14
3.1 GENERAL INFORMATION	14
3.2 TIME MODE	14
3.2.1 Main display	14
3.2.2 Stopwatch	15
3.2.3 Alarm	15
3.2.4 Time/Date	17
3.2.5 Units	19
3.2.6 Setting the position format	22
3.2.7 General	24
3.3 ALTI/BARO MODE	26
3.3.1 Use	26
3.3.2 Alti use	27
3.3.3 Baro use	28

3.3.4	Alti/Baro data display	28
3.3.5	Reference altitude and barometric pressure	29
3.3.6	Barometric Memory	30
3.3.7	Alarm	31
3.4	COMPASS MODE	33
3.4.1	Main display	33
3.4.2	Calibrating the compass	34
3.4.3	Declination	36
3.5	NAVIGATION MODE	37
3.5.1	Using the Navigation mode	37
3.5.2	Main display	38
3.5.3	Creating a route	39
3.5.4	Using a route	42
3.5.5	Editing routes and waypoints	46
3.5.6	Navigation data displays	48
3.5.7	Navidata	50
3.5.8	Track Back (Active track)	51
3.5.9	XTE alarm	52
3.5.10	Reference altitude and barometric pressure	52
3.5.11	GPS fix	52
3.6	ACTIVITY MODE	53
3.6.1	Main Display	53
3.6.2	Activity	54
3.6.3	GPS fix	55
3.6.4	Reference altitude and barometric pressure	56
3.6.5	Memory	56
3.6.6	Track back (track log)	58
3.6.7	Activity data display	59
3.7	FUNCTION MENU	60
3.7.1	GPS	60
3.7.2	Mark Memp	60

3.7.3 Mark Home	61
3.7.4 Find Home	61
3.7.5 Position	63
4. SUUNTO X9 IN ACTION	64
4.1 MONT BLANC CLIMBING	64
4.1.1 Arrival and initial preparations	64
4.1.2 First hiking day	65
4.1.3 Second hiking day	67
4.2 CROSS COUNTRY RUNNING	69
5. GLOBAL POSITIONING SYSTEM (GPS)	70
5.1 HOW TO ENSURE GOOD POSITION MEASUREMENT	70
6. SUUNTO TREK MANAGER	73
6.1 INSTALLATION	73
6.2 SYSTEM REQUIREMENTS	73
6.3 PC INTERFACE	73
6.4 SUUNTO TREK MANAGER FEATURES	74
6.4.1 X9 window (1)	75
6.4.2 Local Data window (2)	76
6.4.3 Map window (3)	78
6.4.4 Profiles window (4)	79
6.4.5 Information window (5)	79
6.4.6 SuuntoSports window (6)	79
7. SUUNTOSPORTS.COM	80
7.1 GETTING STARTED	80
7.2 SECTIONS	81
7.3 MY SUUNTO	81
7.4 COMMUNITIES	81
7.5 SPORT FORUMS	82
8. TECHNICAL SPECIFICATIONS	83
9. GPS DATUM LIST	84
10. LOCAL GRID LIST	92

11. GLOSSARY	93
12. DISCLAIMERS	95
12.1 USER'S RESPONSIBILITY	95
12.2 COPYRIGHT, TRADEMARK AND PATENT NOTICE	95
12.3 CE	95
12.4 LIMITS OF LIABILITY AND ISO 9001 COMPLIANCE	95
12.5 AFTER SALES SERVICE	96
12.6 DISCLAIMER	96

1. GENERAL INFORMATION

The Suunto X9 wristop computer is a reliable high-precision electronic instrument intended for recreational use. Suunto X9 should not be substituted for obtaining measurements that require professional or industrial precision.

NOTE: *Do not use Suunto X9 as the only navigation aid. Use all available navigation aids such as maps, compass, visual sightings etc. and compare them with the Suunto X9 navigation information. Make sure all conflicting information is resolved before continuing with navigation.*

NOTE: *Read this instruction manual carefully and make sure you understand the use, displays and limitations of this instrument before using it.*

1.1. CHECKLIST

Make sure the package contains the following items:

- Suunto X9
- Docking Station
- Charger
- PC-interface cable
- CD containing the Suunto Trek Manager software and the user guide
- Suunto X9 Quick Guide
- Suunto X9 Pocket Guide

Should any of these be missing from the package, contact the resale agent who sold you the package.

1.2. CARE AND MAINTENANCE

Only perform the procedures described in this manual. Never attempt to disassemble or service your Suunto X9. Protect your Suunto X9 from shocks, extreme heat and prolonged exposure to direct sunlight. If not in use, store your Suunto X9 in a clean and dry environment at room temperature.

Your Suunto X9 can be wiped clean with a lightly moistened (warm water) cloth. If there are stubborn stains or marks, you can apply mild soap to the area. Do not expose your Suunto X9 to strong chemicals such as gasoline, cleaning solvents, acetone, alcohol, insect repellents, adhesives and paint, as they will damage the unit's seals, case and finish. Keep the area around the sensor free of dirt and sand. Never insert any objects into the sensor opening.

1.3. WATER RESISTANCE

Suunto X9 is water resistant. Its water resistance is tested to 100m/330ft according to ISO 2281 standard (www.iso.ch). This means that you can use the Suunto X9 for swimming or other water sports activities but it should not be used for scuba diving or freediving.

NOTE: *Do not push the buttons under any circumstances while swimming or in contact with water. Deliberate or unintentional depression of the buttons while the unit is submerged could cause the unit to malfunction.*

NOTE: *Large amounts of water and dirt under the cover of Suunto X9 may disturb the satellite signal reception.*

1.4. CHARGING THE BATTERY

Suunto X9 is equipped with an internal rechargeable battery. You can recharge the battery approximately 500 times. The life expectancy of a single charge can range from 4-5 hours (with heavy usage of the GPS, backlight, compass and data storage functions) to over 2 months if you only use Time and/or Alti/Baro mode.

When the battery level indicator on the display reaches the red zone, the battery voltage is low and you should recharge the battery.

Do not attempt to replace the battery, as this will void warranty. Take your Suunto X9 to an authorized Suunto dealer for a battery replacement.

You can charge the battery with either 110V or 220 V mains charger (depending on the area of purchase), with a car cigarette lighter charger (optional) or with a 9 V battery.

WARNING: *This Suunto product contains a Li-ion battery. To reduce the risk of fire or burns, do not disassemble, crush, puncture, short external contacts or dispose of in fire or water. Only use manufacturer specified batteries. Recycle or dispose of used batteries properly.*

Charging the battery with a mains charger

1. Place your Suunto X9 on the docking station with the display facing up.
2. Plug the charger in the docking station. Plug the charger in an electric outlet.
3. When the battery level indicator is full, disconnect the charger from the electric outlet. Your Suunto X9 is now ready for use.

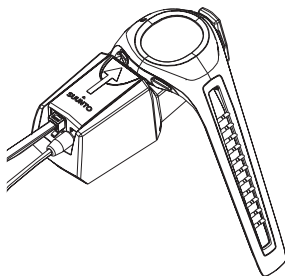
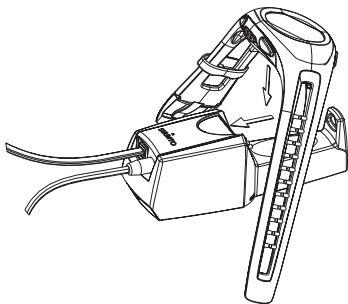

Charging the battery with a 9 V battery

1. Open the battery compartment of the docking station.
2. Insert a 9 V battery.
3. Place your Suunto X9 on the docking station with the display facing up.

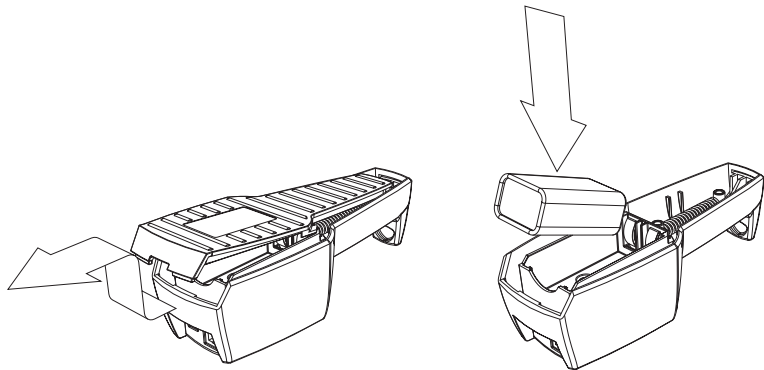

2. HOW TO USE YOUR SUUNTO X9

2.1. DISPLAY AND BUTTONS

2.1.1. Mode indicator

On the left side of the display there is a mode indicator that shows you the currently active mode. The mode indicator displays the modes from the top down in the following order: TIME, ALTI/BARO, COMPASS, NAVIGATION and ACTIVITY. The active mode is indicated by the moving segment next to the indicator bar.

2.1.2. Battery level Indicator

On the right side of the display there is a battery level indicator. When the indicator is in the red zone, the battery needs recharging. When the battery is being recharged, the indicator moves up continuously until the battery is full, and the indicator is shown in full length.

2.1.3. Alarm symbols

Suunto X9 can display three different alarm symbols: Time, weather and altitude. When you set a time alarm, its symbol is displayed at the right side of the lower horizontal dot line. When you set the weather alarm, its symbol appears underneath the left side of the dot line. When you set the altitude alarm, its symbol appears on top of the left side of the dot line”

2.1.4. GPS reception indicator

When the GPS is set on, the GPS reception indicator appears on the upper horizontal dotted line of the display. Once the GPS is on but does not have satellite reception, an empty, rectangular and blinking dot is displayed. When the GPS has a fix, 1 to 5 filled rectangular dots are displayed. The quantity depends on the reception quality. More dots represent better satellite coverage and signal reception.



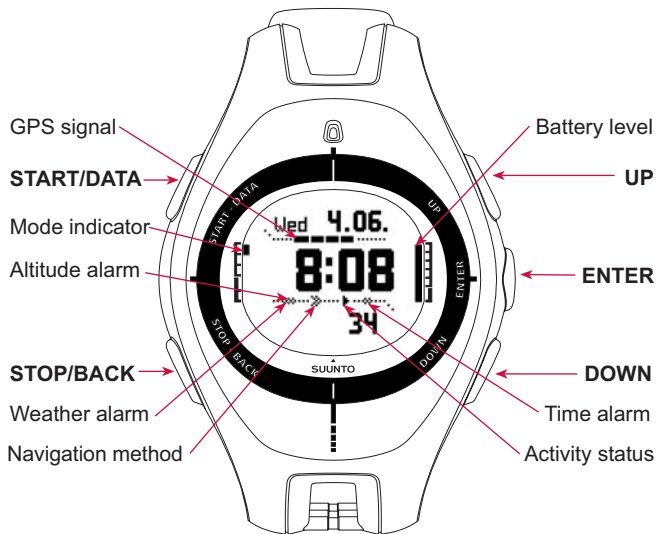

The menus are organized hierarchically under the modes. When you select a mode with UP/DOWN, first the name of the mode is displayed, then its main display opens. When you scroll from one mode to another quickly, only the names of the modes are displayed. When you press ENTER in the mode's main display, the mode's Set menu opens. The Set menu has several functions, all of which have sub-functions or settings.

When you long press ENTER in the main display of any mode, the Function menu opens. It is identical in all the modes. For more information on the Function menu, see section 3.8 Function Menu.

2.2.2. Press and long press

The buttons may have different functions depending on how long you press them. The press means that the button is pressed quickly. The long press means that the button is pressed for more than 2 seconds.

2.2.3. Navigating in the menus

To navigate in the menus:

1. Scroll the menu items with the UP/DOWN buttons located on the right side of Suunto X9. Three menu items are displayed at the same time. The menu item that is currently active and can thus be selected is displayed in reversed color. The indicator bar on the left side of the display shows the active mode.
2. To move deeper in the hierarchy, select a menu item and press ENTER.
3. To return one step up in the hierarchy, press STOP/BACK. Remember that if you only press STOP/BACK, the changes made in the menu are not saved. First you have to accept the changes with ENTER.
4. If you want to return directly to the main display of the active mode, press either ENTER (saves the changes) or STOP/BACK (discards the last change) for more than 2 seconds.

Suunto X9 has been designed to guide you as much as possible when you navigate in the menus. When you perform a function, Suunto X9 often automatically returns to the menu item that you are likely to use next.

3. MODES

3.1. GENERAL INFORMATION

Suunto X9 has five different modes: Time, Alti/Baro, Compass, Navigation and Activity. You can switch between the modes with UP/DOWN. Each mode has several sub-modes. The mode indicator on the left side of the display indicates the active mode.

3.2. TIME MODE

The Time mode includes normal watch functions such as time, date, alarm and stopwatch. In the Time menu you can select the measuring units for the data displayed in other modes, adjust the general settings such as display contrast and button tones and define the GPS position format to match the maps you normally use.

3.2.1. Main display



When you select the Time mode, the main display opens. It has three rows:

Date:

The first row displays the date in the selected format. (For more information on changing the date format, see section 3.2.5. Units.)

Time:

The second row displays the time in the selected format. (For more information on changing between 12- and 24-hour displays, see section 3.2.5. Units.)

Shortcuts:



The third row displays alternatively the stopwatch, the seconds or dual time. Change the displayed information with STOP/BACK.

Stopwatch: Displays the stopwatch. (For information on operating the stopwatch, see section 3.2.2. Stopwatch.)

Seconds: Displays the seconds.

Dual time: Displays a second time zone. (For more information on setting the dual time, see section 3.2.4. Time/Date.)

3.2.2. Stopwatch

To use the stopwatch:

1. Select the stopwatch shortcut with STOP/BACK.
2. Press START/DATA to start the stopwatch. If you want to record a split time, press START/DATA again. The split time stays on the display for three (3) seconds. Then Suunto X9 returns to showing the running time.
3. Press STOP/BACK to stop the stopwatch. If you have recorded any split times, you can now scroll them with STOP/BACK.
4. To reset the timer, long press STOP/BACK. If the stopwatch has not been reset after stopping the timing, press START/DATA to continue the timing from the end time.

Suunto X9 can display up to 29 split times.

NOTE: When you have used the stopwatch, you cannot select other shortcuts before resetting the timer.

NOTE: The maximum time period you can record with the stopwatch is 20 hours.



3.2.3. Alarm

You can set three independent time alarms. When the alarm is set, the time alarm symbol appears on the main display.

Activating alarms

To activate an alarm:

1. In the Set menu, *Alarm* is the first menu item. Press ENTER to select it. The Alarm menu displays the status of the alarms. When you open the menu for the first time, the alarm indicators are set to *Off* as default.
NOTE: You can check the times of sunrise and sunset for reference with START/DATA, in the Alarm List Display. For more information on this, see section 3.3.4. Alti/Baro data display.
2. Scroll to the alarm you want to set and press ENTER. The On/Off field is activated.
3. Press either the UP or DOWN button to change the alarm status to *On*. Press ENTER. The hour selection is activated. The current time is displayed on the bottom



row for reference.

4. Set the correct hour with UP/DOWN and press ENTER. The minute selection is activated.
5. Set the correct minutes with UP/DOWN and press ENTER. The alarm is now set and you return to the Alarm menu.

Deactivating alarms



To deactivate the alarm:

1. In the Set menu, *Alarm* is the first menu item. Press ENTER to select it.
2. Scroll to the alarm you want to deactivate and press ENTER. The alarm information is displayed and the On/Off field is activated.
3. Press either the UP or DOWN button to change the alarm status to *Off* and long press ENTER. The alarm symbol disappears from the main display.

Acknowledging alarms

When you hear the alarm, you can acknowledge it by pressing any of the Suunto X9 buttons. If you do not acknowledge the alarm, it will automatically stop sounding after 30 seconds.

3.2.4. Time/Date

The current time is visible on the second row of the Time mode's main display.

The dual time enables you to keep track of another time, for example, another time zone while traveling. The dual time can be displayed as a shortcut on the third row of the Time mode's main display. Scroll to the dual time shortcut with STOP/BACK.

NOTE: The GPS checks and sets the correct time and date when activated if the Sync function is on. You can change the UTC time offset in the Time/Date function of the Set menu or in the PC. You must always change the dual time manually.

Setting the time and the dual time

To set the time and the dual time:

1. In the Set menu, scroll to *Time/Date* and press ENTER.
2. Scroll to either *Time/Date* or *Dual time* and press ENTER. The hour selection is activated.

NOTE: If the time is displayed in a 12-hour format, the symbol AM or PM is displayed on the left side of the last row. For dual time, the AM/PM-symbol is displayed on the right side of the time. (For more information on the 12/24-hour format, see section 3.2.5. Units.)

3. Change the hour with UP/DOWN and press ENTER. The minute selection is activated.
4. Change the minutes with UP/DOWN and press ENTER. If you are setting the time, the seconds are activated. With dual time you can only set the hours and minutes. The seconds are synchronized with the current time setting.
5. Press DOWN to zero the seconds. If you want to set specific seconds, press and hold UP and the seconds start running. When the seconds are correct, press ENTER. The date selection is activated.
6. Change the day with UP/DOWN and press ENTER. The month selection is activated.
7. Change the month with UP/DOWN and press ENTER. The year selection is activated.
8. Change the year with UP/DOWN and press ENTER. You return to the Time/Date menu.

NOTE: When you set the seconds for the time, they are automatically updated in the dual time as well.



Sync

When the Sync setting is on, Suunto X9 synchronizes the current time from the satellite signal every time the GPS is activated. You will also have to set the correct UTC Offset for your time zone.

If Sync is off, the manually set time is not automatically updated.



To set the time synchronization:

1. In the Set menu, scroll to *Time/Date* and press ENTER.
2. Scroll to *Sync* and press ENTER. The On/Off field is activated.
3. Change the *On/Off* status with UP/DOWN and long press ENTER. The time synchronization is now set. You return to the Time mode's main display.

UTC offset

You can set the UTC offset at 0,5 hour intervals depending on the time zone. For time zones other than Greenwich time (GMT) + full or half-hours, you have to set the time manually and keep Sync off.



To set the UTC offset:

1. In the Set menu, scroll to *Time/Date* and press ENTER.
2. Select *UTC* with UP/DOWN and press ENTER. The offset field is activated and it shows either plus or minus hours from the GMT.
3. Adjust the offset with UP/DOWN and press ENTER. The UTC offset is now set.
4. Press STOP/BACK to return to the Set menu.

3.2.5. Units

The Units menu includes the unit and format settings used with all the Suunto X9 functions. They have an effect on how the information is displayed in all the modes.

Setting the time format

The time format setting defines whether the 12h or 24h format is used.

To change the time format:

1. In the Set menu, scroll to *Units* and press ENTER. The Units menu is displayed.
2. *Time* is the first menu item. Press ENTER to select it. The time format field is activated.
3. Select the desired time format with UP/DOWN and press ENTER. The time format is now set.

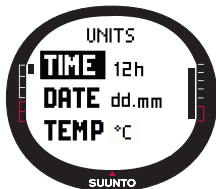

Setting the date format

The date setting defines the format in which the date is displayed. The possible formats are:

- **DD.MM**: Day before the month (27.11).
- **MM.DD**: Month before the day (11.27).

To change the date format:

1. In the Set menu, scroll to *Units* and press ENTER. The Units menu is displayed.
2. Scroll to *Date* and press ENTER. The date format field is activated.
3. Select the desired date format with UP/DOWN and press ENTER. The date format is now set.

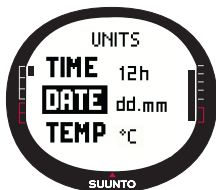

Setting the temperature unit

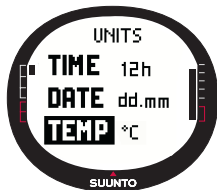

The Temp setting defines the unit in which the temperature is displayed. The options are Celsius (°C) and Fahrenheit (°F).

To change the temperature unit:

1. In the Set menu, scroll to *Units* and press ENTER. The Units menu is displayed.
2. Scroll to *Temp* and press ENTER. The temperature unit field is activated.
3. Select the desired unit with UP/DOWN and press ENTER. The temperature unit is now set.

Setting the barometric pressure unit

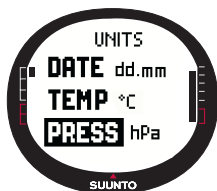

The Press setting defines the unit in which the barometric pressure is displayed. The options are hPa and inHg.

To change the barometric pressure unit:

1. In the Set menu, scroll to *Units* and press ENTER. The Units menu is displayed.
2. Scroll to *Press* and press ENTER. The barometric pressure unit field is activated.
3. Select the desired unit with UP/DOWN and press ENTER. The barometric pressure unit is now set.

Setting the altitude unit



The Altitude setting defines the unit in which the altitude is displayed. The options are meters (m) and feet (ft).

To change the altitude unit:

1. In the Set menu, scroll to *Units* and press ENTER. The Units menu is displayed.
2. Scroll to *Altitude* and press ENTER. The altitude unit field is activated.
3. Select the desired unit with UP/DOWN and press ENTER. The altitude unit is now set.

Setting the vertical speed unit

The Vert setting defines the unit that the altimeter uses. The options are meters per minute (m/min), meters per hour (m/h), feet per minute (ft/min) and feet per hour (ft/h).

To change the vertical speed unit:

1. In the Set menu, scroll to *Units* and press ENTER. The Units menu is displayed.
2. Scroll to *Vert* and press ENTER. The vertical speed unit field is activated.
3. Select the desired unit with UP/DOWN and press ENTER. The vertical speed unit is now set.



Setting the distance unit

The Distance setting defines the unit in which the distance is displayed. The options are kilometers (km) and miles (mi).

To change the distance unit:

1. In the Set menu, scroll to *Units* and press ENTER. The Units menu is displayed.
2. Scroll to *Distance* and press ENTER. The distance unit selection is activated.
3. Select the desired unit with UP/DOWN and press ENTER. The distance unit is now set.



Setting the speed unit

The Speed setting defines the unit in which the speed is displayed. The options are kilometers per hour (km/h) and miles per hour (mph).

To change the speed unit:

1. In the Set menu, scroll to *Units* and press ENTER. The Units menu is displayed.
2. Scroll to *Speed* and press ENTER. The speed unit field is activated.
3. Select the desired unit with UP/DOWN and press ENTER. The speed unit is now set.



Setting the datum



The Datum setting defines the map datum you use. (For more information on different datums and their corresponding numbers, see the GPS Datum List appendix.)

To set the datum:

1. In the Set menu, scroll to *Units* and press ENTER. The Units menu is displayed.
2. Scroll to *Datum* and press ENTER.
3. Select the desired datum number with UP/DOWN and press ENTER. The datum format is now set.

Grid



The Grid setting defines the grid you use. (For more information on different grids, see the Local Grid List appendix.)

To set the grid:

1. In the Set menu, scroll to *Units* and press ENTER. The Units menu is displayed.
2. Scroll to *Grid* and press ENTER.
3. Select the desired grid with UP/DOWN and press ENTER. The grid format is now set.

3.2.6. Setting the position format

The Position setting defines the format in which position coordinates are displayed. The setting has four options:

- **deg**: Degrees (second picture from the left)
- **dm**: Degrees and minutes (middle)
- **grid**: Local metric grid (second from the right, the picture displays the Swiss grid)
- **utm**: Global UTM (first from the right)

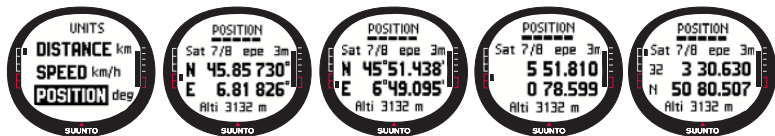

To set the position format:

1. In the Set menu, scroll to *Units* and press ENTER. The Units menu is displayed.
2. Scroll to *Position* and press ENTER.
3. Select the desired format with UP/DOWN and press ENTER. The position format is now set.

The following table shows you the possible position formats and whether they use a datum or a grid.

Pos. format	Datum	Grid
Deg	Set	No adjustment required
Dm	Set	No adjustment required
Grid	No adjustment required	Set
UTM	No adjustment required	No adjustment required

Set: This means that you have to set the correct datum/grid.

No adjustment required: This means that this selection does not have any effect so you do not have to adjust it.

3.2.7. General

The General menu contains several general settings for your Suunto X9.

Setting the light

With the Light setting you can adjust the backlight of the Suunto X9 display. It has three possible settings:

- **Normal:** The light switches on when you press START/DATA for more than 2 seconds, when an alarm is activated or when you reach a waypoint. The light stays on as long as a selection is active and for 5 seconds after the last press of a button.
- **Night Use:** The light switches on when you press any of the buttons and stays on for 5 seconds after the last press of a button.
- **Off:** The light does not switch on from any button or during an alarm.

To change the light settings:

1. In the Set menu, scroll to *General* and press ENTER. The General menu is displayed.
2. *Light* is the first menu item. Press ENTER to select it. The current light setting is displayed in reversed color.
3. Select the suitable light setting with UP/DOWN and press ENTER. The light settings are now ready.



Setting the brightness

This setting adjusts the brightness of the Suunto X9 backlight. The brightness is measured on a scale of 1 to 7. Brighter backlight consumes more battery power.

To change the brightness:

1. In the Set menu, scroll to *General* and press ENTER. The General menu is displayed.
2. Scroll to *Bright* and press ENTER. The brightness setting is activated.
3. Change the value with UP/DOWN and press ENTER. The brightness is now set.



Setting the contrast

This setting adjusts the contrast of the Suunto X9 display. The contrast is measured on a scale of 1 (minimum) to 9 (maximum). The maximum contrast setting consumes more power than the minimum setting.

To change the contrast:

1. In the Set menu, scroll to *General* and press ENTER. The General menu is displayed.
2. Scroll to *Contrast* and press ENTER. The contrast setting is activated.
3. Change the value with UP/DOWN and press ENTER. The contrast is now set.



Setting the tones

Tones are the sounds that indicate that you have successfully pressed the buttons. You can set the tones to On or Off.

To set the tones:

1. In the Set menu, scroll to *General* and press ENTER. The General menu is displayed.
2. Scroll to *Tones* and press ENTER. The On/Off field is activated.
3. Change the value of the field to either *On* or *Off* with UP/DOWN and press ENTER. The tones are now set.



Setting the display information

When the Info function is on and you scroll to a mode with UP/DOWN, the name of the mode appears on the display for a second before the main display opens. When it is off, the main display opens straight away.

To turn the display information on or off:

1. In the Set menu, scroll to *General* and press ENTER. The General menu is displayed.
2. Scroll to *Info* and press ENTER. The display information setting is activated.
3. Change the value of the field to either *On* or *Off* with UP/DOWN and press ENTER. The display information is now set.





3.3.ALT/BARO MODE

The Alti/Baro mode is used for measuring altitude, barometric pressure and temperature. Suunto X9 calculates the altitude from the current barometric pressure, which is more sensitive and accurate than the altitude measurement with the GPS, and is also available when the GPS is off.

Because both altitude and weather data are measured with the same barometric sensor, you have to select whether you want to use this mode as an altimeter or as a weather station.

The Use selection defines the set of information shown on the main display. The Alti/Baro menu also contains weather and altitude alarms, the weather memory, and the reference setting needed to relate the current weather state with your current altitude.

3.3.1. Use

With this function you can set Suunto X9 to display either barometric or altitude-related information.

When the Alti use is active, Suunto X9 assumes that all the barometric pressure changes are due to altitude changes. Alti is intended for measuring altitude whenever you are on the move. However, since substantial barometric pressure changes can take place during a day, you should compare the changes reported by Suunto X9 to well-known references. If these differ from each other too much, the reason is the weather change and you should set a new reference value as advised in section 3.3.5. Reference altitude and barometric pressure. A general rule is that a 10 m change in altitude equals 1,2 hPa in the barometric pressure at sea level and 0,5 hPa at 8000 m.

When the Baro use is active, Suunto X9 assumes that all the barometric pressure changes are due to weather changes. Baro use is practical for following and predicting weather trends when staying in a constant altitude. When the GPS is on, the device uses the atmospheric pressure to measure the altitude reading just like when Alti is set, regardless of which display is selected, Alti or Baro.

To change the Use setting:

1. In the Set menu, scroll to *Use* and press ENTER. The Alti/Baro field is activated.
2. Select *alti* or *baro* with UP/DOWN and press ENTER.
3. Press STOP/BACK to return to the main display.



3.3.2. Alti use

When you select Alti, the following main display opens. It has three rows:

Vertical speed:

The first row displays the vertical speed in the unit of your choice. For more information on setting the vertical speed unit, see section 3.2.5. Units.

Altitude:

The second row displays your altitude from the sea level.

Shortcuts:

The third row displays alternatively the temperature, absolute barometric pressure (abs) or time. Change the displayed information with STOP/BACK.

- **Temperature:** Displays the temperature in the unit of your choice. (For more information on defining the temperature unit, see section 3.2.5. Units.)
- **Absolute barometric pressure (abs):** Displays the actual barometric pressure in your current location.
- **Time:** Displays the current time



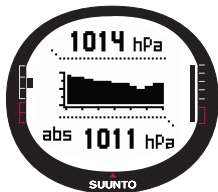

3.3.3. Baro use

When you select Baro, the following main display opens. It has three rows:

Sea level barometric pressure:

The first row displays the barometric pressure at sea level in the unit of your choice.

Barometric pressure graph:

The second row shows a graphical presentation of the barometric pressure development during the last 6 hours in

15-minute intervals.

Shortcuts:

The third row displays alternatively the temperature, absolute barometric pressure (abs) or time. Change the displayed information with STOP/BACK.

- **Temperature:** Displays the temperature in the unit of your choice. (For more information on defining the temperature unit, see section 3.2.5. Units.)
- **Absolute barometric pressure (abs):** Displays the actual pressure in your current location.
- **Time:** Displays the current time.

3.3.4. Alti/Baro data display



The Alti/Baro data display shows you the times of sunrise (tsr) and sunset (tss) on the present day, calculated for your last recorded coordinates. To activate the display, press START/DATA in the Alti/Baro mode's main display. To exit the display, press START/DATA again.

3.3.5. Reference altitude and barometric pressure

To ensure that the altimeter shows correct readings, you first need to set an accurate reference altitude. To do this, go to a location whose altitude you have checked, for example, with the help of a topographical map, and set the reference altitude to match the map reading.

NOTE: *If you do not know the current altitude, go to the Position display and check the altitude with the GPS. The longer the GPS is on, the more accurate the altitude reading will be.*

If you do not have accurate altitude information, you can use the current sea-level barometric pressure as the reference value. Your Suunto X9 will provide you with the current sea-level pressure after you have switched the GPS on. Depending on the quality of satellite reception this may take few minutes. Suunto X9 has a factory-set reference altitude that corresponds to the standard barometric pressure (1013 hPa/ 29.90inHg at sea level).

Setting the reference altitude

To set the reference altitude:

1. In the Set menu, *Reference* is the first menu item. Press ENTER to select it. The reference menu opens.
2. *Altitude* is the first menu item. Press ENTER to select it. The Altitude display opens. The previously set altitude is highlighted.
3. Change the altitude with UP/DOWN and press ENTER. The reference altitude is now set and you return to the Reference menu.





Setting the sea level barometric pressure

To set the sea level barometric pressure:

1. In the Set menu, *Reference* is the first menu item. Press ENTER to select it. The reference menu opens.

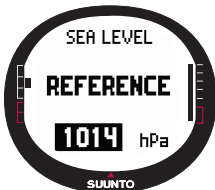

2. Select *Sea level* with UP/DOWN and press ENTER. The Sea level display opens. The previously set sea level pressure is highlighted.

3. Change the pressure with UP/DOWN and press ENTER. The sea level barometric pressure is now set and you return to the Reference menu.

3.3.6. Barometric Memory



The Baro mem function stores weather-related information (sea level barometric pressure and temperature) from the last 7 days/168 hours. Each day has two separate information pages. One for the barometric pressure and the other for the temperature.

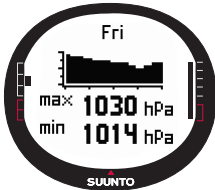

To view the weather information:

1. In the Set menu, scroll to *Baro mem* with UP/DOWN and press ENTER. The first information page is displayed, and you can view the following information:

- Day
- A graphical presentation of the barometric pressure during the day
- Maximum barometric pressure during the day

- Minimum barometric pressure during the day
2. Press the DOWN button to open the next page and you can view the following information:
 - Day
 - A graphical presentation of the temperature during the day
 - Maximum temperature during the day
 - Minimum temperature during the day
 3. View the other days with UP/DOWN. The UP button scrolls forward and the DOWN button backward.
 4. To stop viewing the memory content, press either ENTER or STOP/BACK at any time.



3.3.7. Alarm

With the Alarm function you can define two different alarms; altitude alarm and weather alarm. When you have set an alarm, its symbol appears on the display.

Weather Alarm

Suunto X9 checks the barometric pressure every 15 minutes. The Baro AI function informs you when the barometric pressure changes more than 4 hPa (0.118 inHg) in 3 hours. This is a typically used meteorological value for rapid weather change.

When the GPS is on, the weather alarm is able to detect weather changes even when the altitude is changing.

To activate or deactivate the weather alarm:

1. In the Set menu, scroll to *Alarm* with UP/DOWN and press ENTER. The Alarm menu opens.
2. Scroll to *Baro AI* with UP/DOWN and press ENTER. The On/Off field is activated.
3. Change the field to either *On* or *Off* with UP/DOWN and press ENTER. The weather alarm is now set and you return to the alarm menu.

When the alarm is activated, you hear the alarm signal, the



backlight is turned on and the message 'WEATHER ALARM' is displayed with the current sea-level barometric pressure. You can acknowledge the alarm by pressing any of the Suunto X9 buttons.

Altitude alarm



With the Altitude function you can set an alarm that informs you when you reach the set altitude.

To activate or deactivate the altitude alarm:

1. In the Set menu, scroll to Alarm with UP/DOWN and press ENTER. The Alarm menu opens.
2. Altitude is the first menu item. Press ENTER to activate it. The Altitude alarm display opens and the On/Off field is activated.
3. Change the field to either On or Off with UP/DOWN and press ENTER. The altitude field is activated.
4. Change the altitude with UP/DOWN and press ENTER. The altitude alarm is now set and you return to the alarm menu.

When the alarm is activated, you hear the alarm signal, the backlight is turned on and the message 'ALTITUDE ALARM' is displayed with the current altitude. You can acknowledge the alarm by pressing any of the Suunto X9 buttons. The alarm is activated again when the device goes 50 m above or below the set altitude.

3.4. COMPASS MODE

The compass mode aids the GPS functions and offers you navigational support even when the GPS is off. The 3-axis compass sensor allows tilting up to 30 degrees while still displaying the correct bearing. In the Compass menu you can set the declination and calibrate the compass to ensure accurate readings in any location.



3.4.1. Main display

When you select the Compass mode, the main display opens. The main display has three rows and the circular North indicator:

Cardinal points:

The first row displays the cardinal and half-cardinal point abbreviations.

Heading:

The second row displays the heading in degrees.

Shortcuts:

The third row displays alternatively the time, the bearing lock or the bearing (bea). Change the displayed information with STOP/BACK.

Time: Displays the current time.

Bearing lock: This feature helps you follow a certain bearing. Rotate your Suunto X9 horizontally until the desired bearing is displayed on the second row and press START/DATA. Press START/DATA again to select a new bearing. The bottom row displays the degree deviation, to the left or right, from the target bearing.





Bearing (bea): If you are navigating a route from the Navigation menu, the third shortcut displays the bearing to the next waypoint. If you have not activated a route and the GPS is on, the shortcut displays the bearing to the start position (where the GPS or an activity was switched on). If the GPS is not on, the shortcut displays the latest acquired bearing.

NOTE: *The magnetic sensor of the compass functions for 45 seconds at a time. After this period, the compass goes into power-saving mode and the message 'START COMPASS' is displayed. To activate the compass again, press START/DATA.*

3.4.2. Calibrating the compass

To ensure that the compass works properly, you need to calibrate it.

Calibrate the compass:

- If it does not seem to work well, for example, when it displays the wrong compass heading or the heading changes too slowly.
- If your Suunto X9 has been exposed to strong electromagnetic fields, such as electric lines, loudspeakers and magnets, which can affect the compass operation.
- Before you use it for the first time
- Before you leave for an extended outdoor activity.



To calibrate the compass:

1. In the Set menu, scroll to *Calibrate* and press ENTER. The message 'ROTATE 360° HORIZONTAL', a set of arrows and a 30 second timer are displayed.
2. Hold your Suunto X9 horizontally level and rotate it 360 degrees in the direction of the arrows for 30 seconds. The device beeps and the message 'ROTATE 360 UP', a set of arrows pointing upwards and to the side and a timer are displayed.
3. Hold your Suunto X9 vertically level and rotate it 360 degrees in the direction of the horizontal arrows for 30 seconds. After the time has elapsed, the message 'CALCULATING' is displayed. If the calibration succeeds, the message 'COMPLETE' is displayed. If it does not succeed, the message 'FAILED' is displayed. If this happens, you have to calibrate it again.

4. When the calibration is finished, press ENTER to return to the main display.

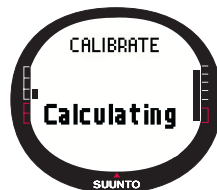
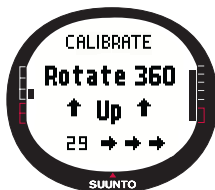

3.4.3. Declination

You can set the compass declination manually or let the GPS do it. The compass declination options are introduced in the table below:

Off	Compass points to the magnetic north.
On	Compass points to the geographic north based on the manually set declination. Use this when you know the exact declination of the location. Normally, you can find this on a topographic map.
Auto	Compass points to the geographic north based on the declination from the GPS database value for the current location. Use this when you do not know the exact declination of the area.

Setting the compass declination manually



To set the compass declination manually:

1. In the Set menu, *Declination* is the first menu item. Press ENTER to select it. The On/Off/Auto field is activated.
2. Select *On* with UP/DOWN and press ENTER. The direction field is activated.
3. Select the desired direction with UP/DOWN and press ENTER. The degree field is activated.
4. Change the degrees with UP/DOWN and press ENTER. The declination is now set and you return to the compass menu.

Setting the compass declination with the GPS

To set the compass declination with the GPS:

1. In the Set menu, *Declination* is the first menu item. Press ENTER to select it. The On/Off/Auto field is activated.
2. Select *Auto* with UP/DOWN and press ENTER. The GPS automatically sets the compass declination.

NOTE: The GPS declination database is based on a global 2-degree latitude x 2-degree longitude grid.



3.5. NAVIGATION MODE

You should use the Navigation mode when you have a pre-planned destination and you want to ensure that you will find it. The mode includes all the typical GPS functions related to routes and waypoints. You can create the routes and waypoints in this mode or on your PC and use them to guide you to your destination. The Navigation mode also shows you the distance, direction, estimated time of arrival and other essential information for all the waypoints of the selected route, and guides you back to your starting point.

The Navigation mode works together with the Activity mode, so even if you do not activate a route, for instance when running, the Navigation mode always shows you the distance and direction to the start.

3.5.1. Using the Navigation mode

This section contains a brief guide on how to use the Navigation mode. You can find more detailed instructions in the sections below.

To use the Navigation mode:

1. Create a route either on Suunto X9 or using Suunto Trek Manager and transfer it to Suunto X9 (section 3.5.3. Creating a route).
2. Select a route (3.5.4.).
3. Activate the first Waypoint (3.5.4.).
4. Choose the preferred navigation method (3.5.4).
5. Start Activity by choosing ► (3.6.2).
6. Start navigating.

3.5.2. Main display



When you select the Navigation mode, the main display opens.

The display is updated according to the selected GPS fix interval. The 1 sec setting updates the display constantly. The 1 min setting updates the display once every minute and when you long press STOP/BACK. The manual setting updates the display every time you long press STOP/BACK.

The main display has three rows and a circular bearing indicator:

Direction to waypoint

If the GPS is on and it has a satellite fix, the upper part of the display has fixed sighting marks and a circular bearing indicator that shows the direction to the next wp. When the bearing indicator is inside the sighting marks, you are moving in the direction of the set bearing.

The circle is closed (completely black) when you navigate using the GPS, and it is open when you use the compass. At slow speeds (when walking) Suunto X9 cannot make out the direction just from the GPS reading and therefore it uses the compass.

Waypoint:

When Navigate is on, the first row displays the name and number of the navigated waypoint. If Navigate is off, it displays the position where the GPS was first activated (this point is named START).



Distance to waypoint:

When the GPS is on, the second row displays the distance to the next waypoint.

Shortcuts:

The third row displays alternatively the time, bearing (bea) or estimated time to waypoint (ttw). Change the displayed information with STOP/BACK. You can select a shortcut from the NaviData function to replace the ttw. (For more information, see

Section 3.5.7. Navidata.)

Time: Displays the current time

Bearing (bea): Displays the bearing to the next waypoint in degrees.

Time to waypoint (ttw): Displays the estimated travel time to the next waypoint based on the current speed.

NOTE: When Navigate is off but the GPS is on, all values refer to the start point.

NOTE: If the GPS is off, the unit always displays the selected route, the total length and the current time.



3.5.3. Creating a route

Suunto X9 does not include any factory-set routes. So, to be able to use the route function, you first need to create a route. You can store up to 50 routes in the memory. Each route can include 50 waypoints, ten of which can be alarm points.

NOTE: It is easier to create routes on a PC with Suunto Trek Manager because you do not have to enter the coordinates manually. You can also import routes from Suuntosports.com. (For more information on creating routes with your PC, see Chapter 6. Suunto Trek Manager.)

Creating a new route

To create a new route:

1. In the Set menu, scroll to *Route* and press ENTER.
2. *Create* is the first menu item. Press ENTER to activate it. The waypoint window opens and the field that shows the waypoint number is highlighted.

NOTE: If the memory already contains 50 routes, the device displays the message 'ROUTE MEMORY FULL'.

NOTE: The information on the waypoint window differs depending on the chosen Position format. (For more information, see section 3.2.6. Setting the position format.)





3. Set the waypoint number with UP/DOWN and press ENTER. The number defines the waypoint location on the route. The name field is activated.

4. Choose the waypoint name with UP/DOWN and press ENTER. The coordinates are activated. If the GPS is on, Suunto X9 displays the current coordinates. If it is off, it displays the coordinates of the last GPS location.

5. Change the coordinates with UP/DOWN and press ENTER. The altitude field is activated.

6. Set the altitude with UP/DOWN and press ENTER. The message 'WAYPOINT STORED' is displayed and the waypoint list opens.
7. Scroll to Create WP and repeat the steps 3-6 if you wish to create more waypoints on this route.

Creating a new waypoint

With this function you can add new waypoints to previously created routes.



To create a new waypoint:

1. In the Set menu, scroll to *Route* and press ENTER. The route list is displayed.

2. Select a route with UP/DOWN and press ENTER. The waypoint list is displayed.

3. In the route menu, scroll to *Create WP* with UP/DOWN and press ENTER. The new waypoint is displayed.

4. Edit the order number, name, coordinates and altitude of the waypoint with UP/DOWN if necessary, and press ENTER.

NOTE: *If the route already contains 50 waypoints, the device displays the message 'ROUTE FULL'.*

NOTE: *When you create routes or waypoints with your Suunto X9, the unit names them according to the current date and time. You can also select a name for the waypoints from the list. The alarm point names differ a bit from the waypoint names in both the headings and the waypoint list. After the order number, the alarm point names have a colon and waypoint names a full stop.*



Creating a new waypoint by linking

Using the Link WP function, you can add a new waypoint with the help of an existing waypoint. For example, you can create a wp in your current location, and link a new wp by providing bearing and distance to the new wp, measured from a map.

To link the new wp with the help of an existing wp:

1. In the Set menu, scroll to *Route* and press ENTER. The route list is displayed.
2. Select a route with UP/DOWN and press ENTER. The waypoint list opens.
3. Select a waypoint with UP/DOWN and press ENTER. The waypoint menu is displayed.
4. Scroll to *Link wp* with UP/DOWN and press ENTER. The attributes of the waypoint are activated.
5. Choose the order number and the name of the new waypoint, and add the bearing and the distance from the previously selected way point.
6. Press STOP/BACK if you want to return to the waypoint list without accepting changes.
7. Long press ENTER to accept the changes and return to the main display.



3.5.4. Using a route

After you have created routes, you can use them for navigation. You can also view individual waypoints.

Activating a route

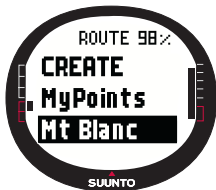

To activate a route for navigation:

1. In the Set menu, scroll to Route and press ENTER. First the message 'LOADING ROUTELIST' and then the list itself is displayed.
2. Select a route with UP/DOWN and press ENTER. The waypoint list and the related functions are displayed.
NOTE: If you long press ENTER, your Suunto X9 activates the selected route immediately.
3. Scroll to Select and press ENTER. The route is loaded and you can view it on the Navigation data display.

Choosing the navigation method

The Navigate function defines the preferred navigation method. If the GPS is off, the Navigate settings determine how the information on the Navigation data display is presented.

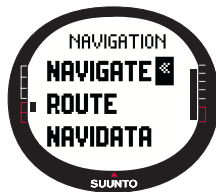

To select the navigation method:

1. In the Set menu, *Navigate* is the first menu item. Press ENTER to select it. The symbol field is activated.
2. Choose a suitable symbol with UP/DOWN and press ENTER.

The symbol options are:

» You will navigate from the beginning or the active waypoint to the end of the route. When you arrive at the waypoint, Suunto X9 will automatically activate the next waypoint.

« You will navigate in the reversed order, from the end or from the active waypoint to the beginning of the route.

◆ You will navigate to a chosen waypoint until you activate another waypoint or change the navigation method.

✕ A route is not activated. You will navigate to the first GPS position (Start) instead of an actual route destination.

◇ This symbol is displayed when you activate a single waypoint on the MyPoints route. This navigation option is only available if you choose a waypoint from the MyPoints route.

NOTE: In normal route navigation, the unit automatically switches to the next waypoint when you arrive inside a 30-meter radius of the waypoint or pass it at a distance further than 100 meters of the perpendicular line to the route that goes through the waypoint.

Changing the active waypoint

You can change the active waypoint in the Navigation data display.

To change the active waypoint:

1. Press START/DATA to open the Navigation data display.
2. Select the desired waypoint with UP/DOWN.
3. Press ENTER to activate the selected waypoint. Suunto X9 starts guiding you to this waypoint.



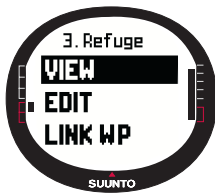

Viewing waypoints

To view waypoints:

1. In the Set menu, scroll to *Route* and press ENTER. The route list is displayed.
2. Select a route with UP/DOWN and press ENTER. A list of waypoints is displayed.
3. Select a waypoint with UP/DOWN and press ENTER. The waypoint menu is displayed.
4. *View* is the first menu item. Press ENTER to select it. The following waypoint information is displayed:

- **Waypoint number:** This tells you the waypoint order on the route.
- **Bearing and distance to the waypoint:** These are calculated from the current location or if the GPS is off, from the previous location.
- **Waypoint coordinates:** The coordinates of the selected waypoint.

NOTE: *The information on the waypoint window differs depending on the chosen Position format. (For more information, see section 3.2.6. Setting the position format.)*

- **Waypoint altitude:** The altitude of the selected waypoint.

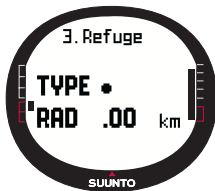

You can also activate an additional data display with START/DATA. The following information is displayed:

- **Point type:** ● = Waypoint and ⚠ = alarm point
 - **Waypoint alarm radius (RAD):** This is only used with alarm points. If the alarm radius is 0, the alarm is not activated. Press START/DATA to exit the additional data display.
5. Press STOP/BACK to exit the waypoint information and return to the waypoint list.

MyPoints

The MyPoints function stores up to 50 individual waypoints (10 of which can be alarm points) that are not affixed to a route in the Suunto X9 memory.

To navigate to a MyPoints wp:

1. In the Set menu, scroll to *Route* and press ENTER. The route list is displayed.
2. Select MyPoints route with UP/DOWN and press ENTER. The waypoint menu opens.
3. Select a waypoint with UP/DOWN and long press ENTER. The navigation to the waypoint is activated and the waypoint name and distance to the destination among other things are displayed on the screen.
4. To stop the My Point navigation, select a new method of navigation.



Alarm points

You can use the alarm points, for example, to warn you about rocks and other hazards. You can set 10 alarm points in the MyPoints function and also 10 for each route. The alarm points for MyPoints are always active when the GPS is on. The alarm points for each route are active when you navigate on the selected route.

When you enter the within the defined radius from the alarm point, for example 0.10 km, the alarm goes on. When the alarm is activated, Suunto X9 displays the name of the alarm point on the top row. The second row displays the text 'WAYPOINT ALARM'. And the third row displays the distance to the alarm point. If you remain in the alarm zone, the alarm is repeated approximately every minute.

NOTE: When you navigate on a route, Suunto X9 does not navigate via the alarm points. However, if you wish to navigate to an alarm point, select **◆** as the navigation method and choose the desired alarm point.

3.5.5. Editing routes and waypoints

You can edit the routes and waypoints you have created and erase those that you no longer need.

Editing waypoints



To edit a waypoint:

1. In the Set menu, scroll to *Route* and press ENTER. The route list is displayed.
2. Select a route with UP/DOWN and press ENTER. The waypoint list is displayed.
3. Select a waypoint with UP/DOWN and press ENTER. The waypoint menu is displayed.
4. Scroll to *Edit* with UP/DOWN and press ENTER. The attributes of the waypoint are activated.
5. Choose the order number of the waypoint in the waypoint

list and change the coordinates and the altitude with UP/DOWN.

NOTE: By pressing *START/DATA* you can activate the additional data display. There you can change the waypoint type and alarm distance.

6. Press ENTER to accept the changes and return to the main display.

Updating the waypoint location

With the Update function, you can replace the coordinates of a waypoint with the coordinates of your current location, provided that the GPS is on.



To update the waypoint location:

1. In the Set menu, scroll to *Route* and press ENTER. The route list is displayed.
2. Select a route with UP/DOWN and press ENTER. The waypoint list is displayed.
3. Select a waypoint with UP/DOWN and press ENTER. The waypoint menu is displayed.
4. Scroll to *Update* with UP/DOWN and press ENTER. The attributes of the waypoint are activated.

5. Press STOP/BACK if you want to return to the waypoint list without accepting changes.

6. Suunto X9 displays the Estimated Position Error (EPE). When the EPE is small

enough, the location is updated automatically. You can also press ENTER to manually update the location before the EPE is small enough for the automatic marking. However, this way the updating will be less accurate.

Erasing a route

To erase a route:

1. In the Set menu, scroll to *Route* and press ENTER. The route list is displayed.
2. Select the route you wish to erase with UP/DOWN and press ENTER.
3. scroll to *Erase* and press ENTER. Suunto X9 asks you to confirm the action.
4. Press ENTER to confirm the action. Suunto X9 displays the message 'ERASING ROUTE', after which you return to the Route menu.

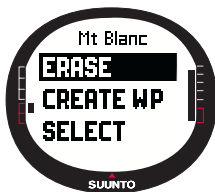

Erasing waypoints

To erase a waypoint:

1. In the Set menu, scroll to *Route* and press ENTER. The route list is displayed.
2. Select a route with UP/DOWN and press ENTER. A list of waypoints is displayed.
3. Select a waypoint with UP/DOWN and press ENTER. The waypoint menu is displayed.
4. Scroll to *Erase* in the waypoint menu and press ENTER. Suunto X9 displays the message 'ERASE WAYPOINT?'.
5. Press ENTER to confirm the action or STOP/BACK to keep the waypoint. You return to the waypoint list.

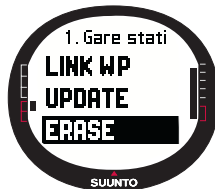

3.5.6. Navigation data displays

All navigation data displays show you information regarding the selected route and its waypoints. The amount of data you receive depends on your selections. You cannot use this function before you have activated a route. If you try to use it before you have activated a route, Suunto X9 asks you to activate one. To open the displays, press START/DATA in the Navigation mode's main display.

Navigation methods > < and ◆

After you have selected a route and pressed START/DATA, you can see a summary page and the route waypoint data pages (as many as there are waypoints) and also alarm points stored on this route. You can scroll the pages with UP/DOWN.

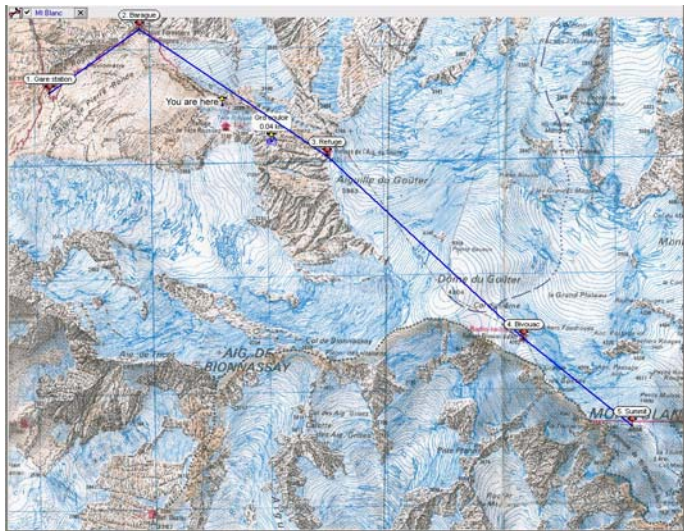

Route summary

The summary displays the name and total length of the route, the number of waypoints and the total ascent.

Waypoint data pages

These pages display the name of the waypoint, distance, bearing and altitude difference. The method how the information is displayed depends on the selected navigation method.

- **><** With these navigation methods, these pages display the information from the previous waypoint to the currently displayed wp.
- **◆** With this navigation method, these pages display the information from the current or last known location to the displayed waypoint.
- **Alarm points**

With alarm points, these pages display the information from the current or last known location to the displayed alarm point.

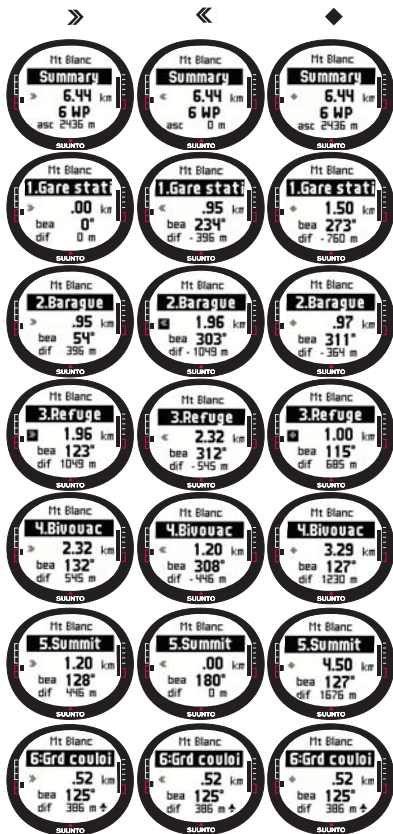

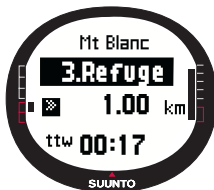

NOTE: If you are currently navigating, and approach the next point, this waypoint data page displays the distance and time to that point.

Navigation methods **✕** **◇** and the Track back function

After you have selected a route and pressed START/DATA, you can only see the summary page. It is similar to the one above.

3.5.7. Navidata

With Navidata you can view different kinds of navigational data and add one of the options as the Navigation mode's shortcut.

To view the Navidata list:

1. In the Set menu, scroll to *Navidata* and press ENTER. The Navidata list opens.
2. Scroll the list (9 items) with UP/DOWN.
3. If you want to select an item as a shortcut, scroll to an item with UP/DOWN and press ENTER. You return to the Set menu and the item appears as a shortcut on the main display. You can also select an item by long pressing ENTER. After this you return to the main display.



4. To exit the display without selecting a shortcut, press STOP/BACK.

Distance to finish (dtf): Displays the distance from the current location to the last waypoint (via each waypoint) in the unit of your choice.

Time to waypoint (ttw): Displays the estimated travel time to the next waypoint based on the current speed.

Estimated time of arrival (eta): Displays the estimated arrival time to the last waypoint based on the current speed.

Estimated time enroute (ete): Displays the estimated travel time to the last waypoint on the route, based on the current speed.

Altitude difference (dif): Displays the altitude difference between your current location and the next waypoint in the unit of your choice.

Altitude to finish (atf): Displays the total amount of ascent from the current location to the last waypoint in the unit of your choice.

Speed (spd): Displays the speed in the unit of your choice.

Heading (hea): Displays the heading in degrees.

Cross track error (xte): Displays the deviation from the course (left/right).



3.5.8. Track Back (Active track)

The Track Back function starts the navigation along the currently active track log to the starting location.

To activate the Track Back function:

1. In the Set menu, select *Track Back* with UP/DOWN and press ENTER. The message 'START TRACK BACK?' is displayed.
2. Press ENTER to confirm the selection. Suunto X9 takes you to the Navigation mode's main display and activates the navigation to the starting location. The Track Back functions just like the navigation, with the exception that you cannot view additional data displays. The destination is displayed on the top row.
3. To stop the Track Back navigation, choose ✕ as the navigation option, ■ as the activity option or turn off the GPS in the Function Menu.



NOTE: Starting the Track back function activates a new track log file.

NOTE: To view the total distance to the starting location, select *dtf* as a shortcut (see section 3.6.6.).



3.5.9.XTE alarm

You can set Suunto X9 to sound an alarm at a certain Cross Track Error (xte). When the alarm is activated, the message 'ALARM' and the current xte are displayed. For example 'ALARM XTE 0.50 KM'.When the xte reaches the set limit, Suunto X9 sounds the alarm every 10 seconds as long as you are outside the set xte.

To set the xte alarm:

- 1.In the Set menu, select *XTE Alarm* with UP/DOWN and press ENTER. The On/Off field is activated.
2. Set the alarm On or Off with UP/DOWN and press ENTER. The XTE field is activated.
- 3.Set the desired XTE with UP/DOWN and press ENTER. The XTE Alarm is now set and you return to the Set menu.

NOTE: To view the XTE information, select *xte* as a shortcut.



3.5.10.Reference altitude and barometric pressure

This function is similar to the one in the Alti/Baro mode. For more information, see Section 3.3.5.

3.5.11.GPS fix

This function is similar to the one in the Activity mode. For more information, see section 3.6.3. GPS fix.

3.6. ACTIVITY MODE

While the Navigation mode shows you where to go, the Activity mode displays your current performance. It is the mode you need when you want to measure and record your activity, be it running in your neighborhood or navigating in the wilderness.

The Activity mode shows you the speed, traveled distance, time from start and other interesting data regarding your current activity. It records your track with the speed and altitude profile that you can view on your PC. It also records memory points if you have marked them. It gives you a log summary at any time on the road with just a push of a button.

3.6.1. Main Display

When you select the Activity mode, the main display opens.

The display is updated according to the selected GPS fix interval. The 1 second setting updates the display constantly. The 1 minute setting updates the display once every minute and when you long press STOP/BACK. The manual setting updates the display every time you long press STOP/BACK. The display has three rows:

Speed:

The first row displays the speed in the unit of your choice.

Distance traveled:

The second row displays the distance you have traveled, in the unit of your choice.

Shortcuts:

The third row displays alternatively the time, time from start (tfs) or altitude. Switch between these with STOP/BACK.

Time: Displays the current time

Time from start (tfs): Displays the time from the start.

Altitude: Displays the current altitude in the unit of your choice.

NOTE: You can also view an additional data display by pressing START/DATA. (For more information, see section 3.6.7. Activity data display.)





3.6.2.Activity

The Activity function records data from a track.

To use the Activity function:

1. In the Set menu, *Activity* is the first menu item. Press ENTER to select it. The symbol field is activated.
2. Choose the desired activity symbol with UP/DOWN and press ENTER. The symbol options are:



This turns on the GPS and the Navigate function according to their previously adjusted settings. The message

'LOG FILE STARTED' is displayed.



This turns off the GPS and closes the total log. The message 'LOG FILE STOPPED' is displayed.



This turns off the GPS temporarily and adds distance information in the log. The message 'LOG FILE PAUSED' is displayed. When you select ►, the GPS is activated again and the recording continues from the previous position.

NOTE: You can also include memory points in the track log with the *Mark Memp* function. (For more information, see section 3.7.2 *Mark Memp*.)

3.6.3. GPS fix

The selected GPS fix interval determines how often your Suunto X9 establishes a satellite connection and how often it stores data in the memory. This in turn affects the battery life.

To select a GPS fix:

1. In the Set menu, select *GPS fix* with UP/DOWN and press ENTER. The fix interval field is activated.
2. Select a suitable fix interval with UP/DOWN and press ENTER.

When the Navigate function is on, your Suunto X9 uses the following settings depending on the chosen fix interval.



GPS fix interval	Estimated duration	Track log interval	Altitude profile interval	Memory capacity (max. 25 track logs)
1 sec	4,5 h	10 s	10 s	24 h
1 min	12 h	1 min	20 s	145 h
Manual	Depends on usage, >500 positions	Manual	60 s	up to 400 h

NOTE: You can change GPS fix settings during an activity.

NOTE: If you have selected the Manual or 1 min, you can reactivate the GPS by pressing STOP/BACK for more than 2 seconds. This is possible in the following modes and functions: Activity and Navigation main displays, Find Home and Position.

Mark MEMP and Mark Home activate the GPS automatically and after marking the point return to the previously selected GPS fix.

NOTE: If you use the Manual or 1 min, the GPS accuracy and activity bar acts normally when the GPS is active. When the GPS is in the sleep mode (saving battery power), it displays ▼ when the data from the last location was valid. It displays □

when the data was not sufficient.

NOTE: If you want to only record the altitude profile of your activity without GPS positioning, set the GPS fix interval to Manual and start the activity.

3.6.4. Reference altitude and barometric pressure

This function is similar to the one in the Alti/Baro mode. For more information, see section 3.3.5



3.6.5. Memory

The Memory function displays the amount of free memory and the list of log files.

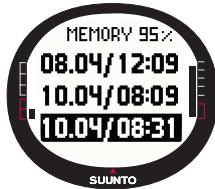

To use the Memory function:

1. In the Set menu, select *Memory* with UP/DOWN and press ENTER.
2. Select the desired log file with UP/DOWN and press ENTER. Now you can either view the file or erase it.

Viewing log files

To view a log file:

1. *View* is displayed in reversed color. Press ENTER to select it. You can scroll the log information pages with UP/DOWN. Suunto X9 displays the following information:
 - Name of the file (always visible on the top row)
 - Distance traveled (dfs)
 - Time from start (tfs)
 - Maximum speed (max)
 - Average speed (avg)
 - Total ascent (asc)
 - Total descent (dsc)
 - Highest altitude (high)
 - Lowest altitude (low)
 - Total number of runs (A run is a vertical movement of ascent and descent equaling 150ft/50m or more)
2. Press STOP/BACK to exit the log information.

Erasing log files

Your Suunto X9 can store up to 25 log files in the memory. When it is full, you have to erase existing files to make room for new ones.

To erase a log file:

1. Select *Erase* with UP/DOWN and press ENTER. The message 'ERASE LOG FILE?' is displayed.
2. Press ENTER to confirm the action. The message 'LOG FILE ERASED' is displayed.
3. Press STOP/BACK to exit the log information.



3.6.6. Track back (track log)

You can use the Activity mode's Track Back function to navigate along any track log file found in the memory. Suunto X9 will guide you to the nearest waypoint and from there to the starting location, or to the finish if you so choose.

To activate the Track Back function:

1. In the Set menu, select ► as the Activity option. This starts storing data in a log file for the Track Back function.



2. Wait until the GPS acquires a connection.
3. In the Set menu, select *Memory* with UP/DOWN and press ENTER.
4. Select the desired log file with UP/DOWN and press ENTER.
5. Select *Track Back* with UP/DOWN and press ENTER. The message 'START TRACK BACK?' is displayed. If the message 'START LOG' is displayed, check that the activity is set to ► and that the unit has received the first satellite fix.

6. Press ENTER to confirm the selection. Suunto X9 takes you back to the Activity display and activates the navigation. It will first guide you to the nearest waypoint and from there to the starting location. The Track Back works just like the navigation, with the exception that you cannot view additional data displays. 'TRACK BACK' is displayed on the top row.

NOTE: The *Track Back* guidance is displayed in the Navigation mode even though you set the function in the Activity mode.



7. To stop the Track Back navigation, choose ✕ as the navigation option, ■ as the activity option or turn off the GPS.

NOTE: To view the total distance to the starting location, select *dtf* as a shortcut.

NOTE: Choose ◀ as the navigation option if you want to navigate to the starting location. choose ▶ if you want to navigate to the finish.

3.6.7. Activity data display

The Activity data display shows you the information summary for the current activity or in case you do not have a current one, the latest activity. To activate the display, press START/DATA in the Activity mode's main display. The information is displayed on four pages. The pages change automatically every 3 seconds after which the device returns to the Activity mode's main display. To exit the display earlier, press START/DATA again.

You can view the following information in the Activity data display:

- Maximum speed (max)
- Average speed (avg)
- Total ascent (asc)
- Total descent (dsc)
- Highest altitude (high)
- Lowest altitude (low)
- Total number of runs (A run is a vertical movement of ascent and descent equaling 150ft/50m or more)



3.7. FUNCTION MENU

To enter the Function menu, long press ENTER in any of the main displays. The Function menu opens and the following functions are available.

3.7.1. GPS

The GPS function allows you to turn the GPS on or off.



To turn the GPS on or off:

1. In the Function menu, *GPS* is the first menu item. Press ENTER to select it. The On/Off field is activated.
2. Change the status to *On* or *Off* with UP/DOWN and long press ENTER. The GPS activity and accuracy bar display appears on the main display.

NOTE: *If you activate the GPS in the Function menu, it does not open the log.*

3.7.2. Mark Memp

The Mark Memp function stores the compass heading, the coordinates and the altitude of the current location.



To mark a memory point:

1. In the Function menu, scroll to *Mark Memp* and press ENTER. The possible name options are displayed.
2. Select a suitable name or accept the current date/time as the name and press ENTER. The compass heading, Estimated position error (epe), coordinates and the altitude of the location are displayed.
3. When the EPE is small enough, the location is marked automatically. The message 'MEMPOINT STORED' is displayed and you return to the main display.

You can also press ENTER to manually mark the location before the EPE is small enough for the automatic marking. However, this way the location information will be less accurate.

NOTE: *Make sure the Activity is ► before using the Memory point function. Activating the Memory point function does not automatically activate the GPS.*

NOTE: *You can view the memory points only with the Suunto Trek Manager software.*

3.7.3. Mark Home

With Mark Home function you can store a position where you wish to return. After storing the position, you can start searching for it with the Find Home function.

To store a position:

1. In the Function menu, scroll to *Mark Home* and press ENTER. The Mark Home display opens.
2. If the GPS is on, the device displays the EPE (Estimated Position Error) right away. When the EPE is small enough, the device stores a position.
3. If the GPS is initially off, it is automatically activated when you select the Mark Home function. In this case the location is only stored after the GPS gets the current location coordinates and can display the EPE. This might take some time.
4. When the EPE is small enough, the location is marked automatically. You can also press enter to manually mark the location before the EPE is small enough for the automatic marking. However, this way the location information will be less accurate.
5. To exit the display and interrupt the function, press STOP/BACK.

NOTE: *Suunto X9 uses the GPS for guidance when you are moving. When you stand still, the compass bearing shows you the direction to the marked position.*



3.7.4. Find Home

The Find Home function guides you back to the position you last marked with Mark Home. The display is updated according to the selected GPS fix interval. The 1 second setting updates the display constantly. The 1 minute setting updates the display once every minute and when you long press STOP/BACK. The manual setting updates the display every time you long press STOP/BACK.



The Find Home display shows the following information:

Heading: The sighting marks appear on the upper corner of the display and the circular bearing indicator appears on the outer rim of the display. When the bearing indicator is inside the sighting marks, you are moving in the direction of the set bearing.

Home: The first row displays the name of the stored position.

Distance: The second row displays the distance to the stored position.

Estimated time enroute (ete): The third row displays the estimated travel time to your current destination based on the current speed.

To activate the Find Home function:



1. In the Function menu, scroll to *Find Home* and press ENTER. If the GPS is on, the device displays the Find Home information immediately. If the GPS is off, it is automatically activated when you select the Find Home function. In this case it takes a while before the information is displayed. Meanwhile the message 'WAIT' is displayed on the upper row.
2. Use the bearing indicator to find the stored position.
3. Press STOP/BACK to exit the function. You return to the Function menu.

NOTE: *The stored location will not disappear when you turn off the Find Home function. The location remains in the memory until you store a new location.*

Find Home data display

The Find Home function has a special information display that contains the coordinates and the recording time of the stored position. The coordinates are displayed in the unit of your choice. (For more information of the position format, see section 3.2.6. Setting the position format.)

To view the Find Home data display:

1. In the Find Home display, press START/DATA to enter the Find Home Data display. There you can see the recording time on the upper row and the coordinates and the bearing on the lower rows.
2. Press STOP/BACK to exit the Find Home Data display.



3.7.5. Position

The Position function allows you to view the current position on the display. The information on the waypoint window differs depending on the chosen Position format. (For more information, see section 3.2.6. Setting the position format.)

The display is updated according to the selected GPS fix interval. The 1 second setting updates the display constantly. The 1 minute setting updates the display once every minute and when you long press STOP/BACK. The manual setting updates the display every time you long press STOP/BACK.

To view the position:

1. In the Function menu, scroll to *Position* and press ENTER.

The following information is displayed:

- **Satellites (Sat):** The first number is the number of satellites used in the positioning and the second is the number of currently visible satellites.
- **Epe:** Displays the estimated position error of the GPS reading.
- **Coordinates:** Displays the coordinates of the position.
- **Altitude:** Displays the current GPS altitude in the unit of your choice.

2. Use START/DATA to toggle between the altitude and time to the first satellite fix.
3. Press STOP/BACK to return to the Function menu.

NOTE: If the GPS is not on when you enter the position menu, the coordinates of the last GPS position are displayed.

NOTE: The position coordinates are updated when the device's position changes.

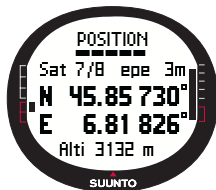

4. SUUNTO X9 IN ACTION

4.1. MONT BLANC CLIMBING

In this chapter you will follow an American mountaineer on his independent two-day trip to the summit of Mont Blanc along the Gouter route. In the previous chapters you have acquired theoretical knowledge on how to use all the Suunto X9 functions and in this chapter you will find out how to apply that knowledge in the field.

4.1.1. Arrival and initial preparations

It is a sunny afternoon when Mike Mountaineer arrives in Col De Voza, France. Since the time zone in France differs from the one in California, he asks the locals what time it is, changes the time in his Suunto X9 and sets the Californian time as the Dual time for reference.

Had he shown a bit more initiative, he could have checked what the UTC difference in France is beforehand, and adjusted it accordingly. Then the GPS would have synchronized the time automatically. However, Mike can adjust the time pretty quickly since on his recent trip to Nepal he had to do it manually anyway because Suunto X9 cannot adjust the UTC to a 15-minute reading interval, which is required in Nepal.

He checks the time and has plenty of time to catch the train to Gare. He locates the correct platform. There he checks the current altitude on the map, and changes the Suunto X9's reference altitude to 1,653 meters in the Alti/Baro mode. Since he is going to be on the move for a while, he sets the Alti mode on with the Use function so that he can monitor the altitude changes en route.

The train trip is relaxing, and he lets his eyes absorb the picturesque landscape while he talks with fellow travelers. When he arrives in Gare, he checks the altitude reading and confirms that it is exactly 2,372 meters just like the map says.

4.1.2. First hiking day

While starting to hike, he sets the GPS fix to 1 sec in the Activity mode and selects ▶ as the Activity option. He chooses the 1 sec option because he wants the GPS to update the information as often as possible. Although this option also consumes a lot of battery power, he knows that the battery will still last throughout his 4-hour hike. He lets the GPS gather data from the satellites for 10 minutes while he tightens his shoelaces, checks his backpack and puts on his harness.

Mike has created the routes for both hiking days with Suunto Trek Manager and uploaded them on his Suunto X9 in advance. Even though he does not really need a navigational aid since the weather is fairly clear and paths are clearly marked, he nevertheless activates a route in the Navigation mode since it does not consume that much battery power even when the Activity is on. This allows him to practice using the Navigation mode in safe conditions, and gather valuable route-specific information such as distances, altitude differences and travel times.

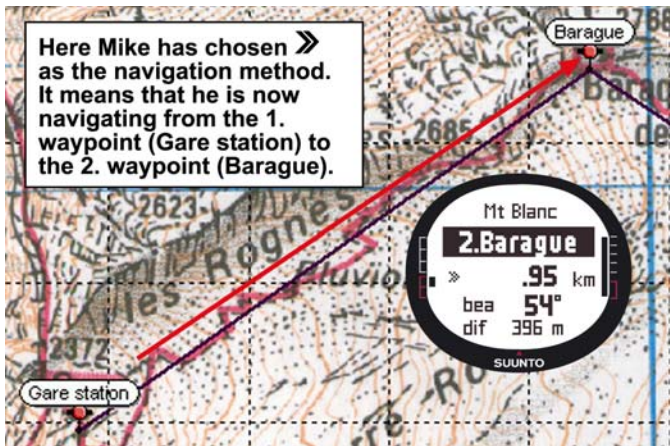

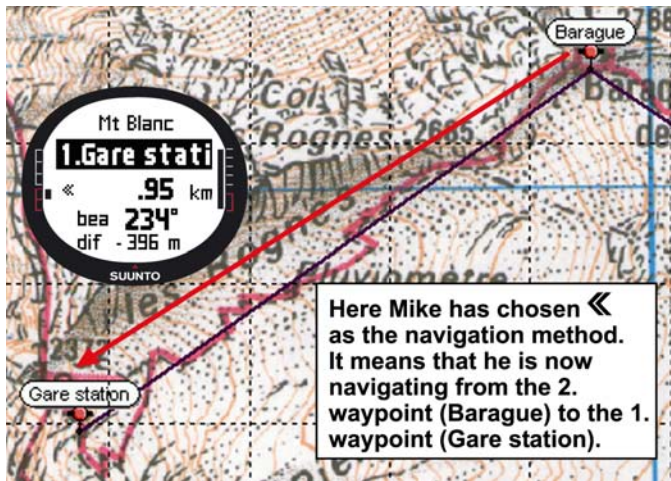

As he enjoys the beautiful scenery on his hike towards Glacier de Tete Rouse, he also notices that clouds are dispersing from the sky, which gives him a reason to suspect that the barometric pressure has changed.

After arriving at Refuge l'Aig du Gouter, Mike sets the Baro mode on so that the barometric pressure changes do not affect the altitude readings anymore.

Before hitting the sack, Mike plans out the next day's activities. He needs to get up early because he has a long way to travel. So, first he checks the time of sunrise with Start/Data in the Alarm menu and then sets an alarm to wake him up just before dawn. He also compares the altitude reading to the one on the map to see that they match. Then he leaves Suunto X9 to charge its battery.

4.1.3. Second hiking day

Right on time, Mike wakes up to a beeping sound, shuts down the alarm with a press of a button, and checks the Baro mode. He is happy to notice that the barometric pressure is on the rise, which augurs good weather.

Before setting off, Mike switches his Suunto X9 to the Alti mode so that he can use the altimeter as a navigational aid, and of course that he can monitor how far it is to the top. While waiting for his breakfast to be ready, he calibrates the compass to make sure it works properly. He also sets the declination to the Auto setting so that he does not need to look at the map too often.

Mike navigates using the Suunto X9 compass together with the uploaded routes, the altimeter and the map. Just like with a regular compass, he checks from time to time that the compass works properly. If the bearing indicator stops moving or the cardinal points seem to be in weird directions, he calibrates the compass again.

Even though the weather conditions are excellent and there is not a cloud in the sky, Mike is also prepared for a whiteout, which would reduce visibility drastically and cause problems to the GPS signal reception. He has practiced taking his bearings using a map and transferring them to his Suunto X9 on dozens of easier routes where mistakes do not have as dramatic consequences.

Mike has planned the trip carefully, trained meticulously on easier cliffs, purchased proper equipment and learned how to use it. He is now ready for the arduous journey that will take him to the top.

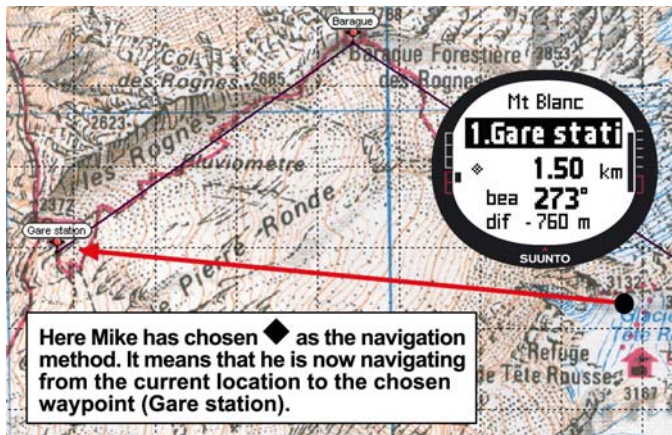

4.2. CROSS COUNTRY RUNNING

This section describes a typical way to use your Suunto X9 in such sports activities as running or cycling, where speed and distance information is needed more often than navigation.

Early Sunday morning, Roger Runner wakes up to the beep of his Suunto X9. It is time for his 30km run, one of the most important training sessions on his preparation for the Mont Blanc trail marathon. After breakfast, he fills his hydration pack, puts on his running shoes and is ready to go.

Outside the front door, he scrolls to the Activity mode of his Suunto X9 and sets the activity to ► . He waits a short while for the satellite reception and checks that the GPS fix interval has been set to 1 sec, giving him the fastest sampling rate for speed, distance and memory recording. Living on the outskirts of the Jura mountain range in France, he likes to run on the nearby hills, and is interested in the altitude readings on his run. Therefore he selects the altitude for the bottom row of the Activity mode. Then he hits the road.

While running, Roger keeps an eye on his speed and follows the distance on the display. On the eight kilometer mark, he checks the current time by selecting it on the bottom row with STOP/BACK. Another press of the button brings the time from start on the display. He keeps on running and checking these pieces of information every now and then. On about three km intervals he takes a sip of sports drink and views the summary data of his run. With one press of START/DATA he sees his average and maximum speed, total ascent and descent and other useful information.

Roger has some adventurer blood in his veins, and he often finds unknown tracks irresistible. This time he runs farther than usual and finds a nice new single track. After a few turns and crossings on the new path, he has 18 km on the display but is no longer sure how to get back home. He switches to the Navigation mode and finds out that the starting point is located exactly 7.54km away, almost in the opposite direction. So, he turns around and after ten minutes recognizes the surroundings again. From there he chooses a flat track he knows, and where he can maintain a constant 12km/h speed more easily than on the hills. Well, if that can be called easy after two hours of constant running.

5. GLOBAL POSITIONING SYSTEM (GPS)

Suunto X9 uses Global Positioning System (GPS) in determining the user's position. GPS incorporates a set of satellites that orbit the Earth at the altitude of 20 000 km at the speed of 4 km/s. The satellites send relatively weak radio signals at power levels comparable to normal household light bulbs. Because the GPS signals that reach the Earth are thousands of times weaker than e.g. cell phone signals, the GPS reception gets disturbed much more easily than the cellular phone signal reception. However, the built-in GPS radio receiver is extremely sensitive and it can pick up even the faintest signals.

The GPS system is run by the United States Department of Defense and has been fully operational since 1995. At least 24 operational satellites circle the globe every 12 hours in 6 orbital planes with 4 satellites per plane to provide a true global coverage. A worldwide ground control network monitors the health and status of the satellites. The system works 24 hours a day regardless of the weather. It can provide service to an unlimited number of users and it is free of charge.

5.1. HOW TO ENSURE GOOD POSITION MEASUREMENT

Using the GPS receiver of your Suunto X9 is very easy. For more information on the actual usage, see Section 3.7.1. However, ensuring good position measurement is a bit trickier. This section contains instructions on how to achieve the best possible results.

MAKE SURE YOU HAVE THE BEST LINE-OF-SIGHT CONNECTION AVAILABLE

To ensure faster and more reliable position measurement, there must be a line-of-sight connection between the satellites and the receiver. This means that the objects or materials between the satellites and the GPS receiver must not excessively attenuate the signal. The list below displays the possible line-of-sight conditions from the best to the worst:

- **Open area with a clear view to the sky**

The best connection is acquired when there is an unobstructed view to the sky. Therefore you should always activate the GPS on fields, hills and other open areas, if possible.

- **Relatively thin plastic, fabric or wooden covers**

The receiver usually works well inside tents and other thin covers.

- **Water-containing objects**

If possible, stay clear from people, trees or other dense vegetation when activating the GPS. They can cause problems to the signal reception. If you are in a forest, try to find an open or scarcely wooded area before activating the GPS.

- **Rocks, buildings or any metallic materials**

The GPS signals will not penetrate any solid constructions. Therefore do not try to activate the GPS inside caves, buildings or any other equivalent constructions.

ACTIVATE THE GPS AT LEAST ONCE BEFORE LEAVING FOR AN EXTENDED OUTDOOR ACTIVITY

When you activate the GPS for the first time, it will take longer than usual since the GPS has no reference to its current location. This may also happen if the GPS has not been used for a long time. Subsequent GPS starts will take less time. The reason for the slow initial fix is that the antenna is optimized for a wrist unit use. Hand-held GPS receivers typically have a patch antenna with highly directional radiation pattern. This gives good sensitivity and uninterrupted data flow when the unit is facing up.

Suunto X9 has a loop antenna that has a wide radiation pattern. It receives data from a very wide angle. There is a clear functional reason for this: Wide reception angle is necessary for the Suunto X9 to ensure fluent operation in all positions when the unit is worn around the wrist. However, due to the wide angle, the sensitivity of reception is not as good as in hand-held GPSs with a narrow radiation pattern.

To minimize the GPS initiation time, hold the unit steady in one position with the display facing up and make sure you are located in an open area so that the unit has a clear view to the sky.

RESERVE ENOUGH TIME FOR THE MEASUREMENT

When the GPS is activated, the receiver starts searching for radio signals from the satellites and as soon as one is found, data starts flowing from the satellite to the receiver. The data flows quite slowly and usually a little less than a minute is needed for the first position estimate. The data includes a list of the satellite positions and the GPS time. You need these before you can perform the actual position calculation and before the GPS becomes functional. The GPS time is highly accurate because each satellite has an atomic clock on board.

After the first position fix has been established, it still takes additional 12 minutes before the GPS has received all optional data from the satellites. After it has a fix, you can move the unit more freely without losing the connection to the satellites. The

downloaded data is valid roughly for the next four hours during which you can activate the receiver more quickly, typically in 90 seconds, if you turned it off in between. Some downloaded data remains valid for several weeks, and subsequent GPS starts will take less time.

STRIVE FOR IDEAL ACCURACY CONDITIONS

Under all-in-view satellite conditions a global average horizontal positioning error is 7.8 meters (95% confidence level). However, depending on the satellite constellation and the distortion the GPS signal experiences when traveling through the ionosphere, the instantaneous accuracy can vary from a couple of meters to over ten meters. The vertical position estimate is roughly two times more inaccurate than the horizontal.

The following factors affect the position accuracy:

- **Relative geometric position of the satellites.** This is the most important factor. The best position estimate is obtained when satellites from four different directions and angles can be tracked. In other words, the less obstructed the receiver's view of the sky, the better the accuracy.
- **Number of satellites being tracked.** To calculate a position, a GPS receiver usually requires simultaneous reception from at least four satellites. The more satellites there are, the better the accuracy is.
- **Number of measurements made on the same spot.** When you make more measurements, some errors will be averaged out.

MAKE SURE THE BATTERY IS FULLY CHARGED AND TURN OFF THE GPS WHEN YOU DO NOT NEED IT

Satellite tracking consumes a lot of battery power. Even though Suunto X9 uses the lowest power consuming GPS technology available, you should charge the battery before you leave for an extended outdoor activity. To increase the battery life, always turn off the GPS when you do not need it or use the manual GPS fix interval.

6. SUUNTO TREK MANAGER

Suunto Trek Manager (STM) is a software designed to enhance the functionality of your Suunto X9. You can use it to perform various tasks such as transferring routes or waypoints stored in the Suunto X9 memory. When you have transferred the data, you can easily organize, view and add related information in it.

The Suunto Trek Manager software is included in your Suunto X9 package on a CD-ROM. You can always download the latest version of Suunto Trek Manager from www.suunto.com or www.suuntosports.com. Please check for updates regularly as new features are developed continuously.

6.1. INSTALLATION

To install Suunto Trek Manager:

1. Insert the Suunto Trek Manager CD-ROM into the drive.
2. Wait for the installation to begin and follow the installation instructions.

NOTE: *If the installation does not start automatically, click Start --> Run and type D:\setup.exe.*

6.2. SYSTEM REQUIREMENTS

- Minimum CPU speed 350 Mhz
- 64 MB of RAM
- 40 MB of available hard-disk space
- Microsoft® Windows 98, Windows NT, Windows 2000, Windows XP
- Minimum resolution: 1024 x 768

6.3. PC INTERFACE

With the PC interface cable you can transfer information between your Suunto X9 and your computer. The interface cable is delivered in the same package with your Suunto X9.

6.4. SUUNTO TREK MANAGER FEATURES

The Suunto Trek Manager display is divided into six separate windows. These windows are shown in the figure below and their functions are briefly introduced in the following sections. (For more detailed instructions, see Suunto Trek Manager Help.)

The screenshot displays the Suunto Trek Manager 6.4.2 interface. The main window shows a topographic map of the Mont Blanc region with a blue route line. The interface is divided into several sections:

- 1**: File menu (File: New, Open, Print)
- 2**: Local Data panel (Left sidebar) showing a list of files and folders, including 'M Blanc', 'Energie', 'Refuge', 'Bivouac', 'Sommet', 'Wp', and 'Alarm Point'.
- 3**: Map displayed (Map displayed: kartis_300 copy) showing the route on a topographic map with labels like 'Mt Blanc', 'Col de des Rognees', 'Baraque Forestiere', 'Pluviometre', and 'de Pierre-Ronde'.
- 4**: Profiles panel (Bottom middle) showing a graph of elevation (0 ft to 0 kmh) over distance (00:00).
- 5**: Route panel (Bottom right) showing a table of route segments with columns for Number, Name, Latitude, Longitude, Altitude, Trip, Distance, and Course.
- 6**: Website information (Bottom left) showing 'SuuntoSports.com' and 'www.suuntosports.com'.

Number	Name	Latitude	Longitude	Altitude	Trip	Distance	Course to...
1	Gate station	45°51'...	006°42'...	7782 ft	0.00 km	0.95 km	54
2	Baraque	45°51'...	006°48'...	9081 ft	0.95 km	1.96 km	123
3	Refuge	45°51'...	006°49'...	12623 ft	2.91 km	2.32 km	132
4	Bivouac	45°50'...	006°51'...	14011 ft	5.24 km	1.20 km	129
5	Sommet	45°49'...	006°51'...	15774 ft	6.44 km	3.52 km	311
6	Wp	45°51'...	006°49'...	0 ft	9.97 km	0.00 km	

6.4.1. X9 window (1)



The toolbar on the top of the X9 window contains four icons:

- **Connect to X9:** With this icon you can create the connection between your Suunto X9 and STM.
- **Download selected item(s) to folder:** With this icon you can transfer data from Suunto X9 to STM.
- **Delete selected item:** First select the items you want and then click on this icon to delete them from the Suunto X9 memory.
- **Clear X9 memory:** With this icon you can delete all the items in the Suunto X9 memory at once.

You can also select routes, tracks and other information for viewing. When you select a file, its data is displayed in the Information window (5).

Transferring Data

To transfer data:

1. Make sure your computer has a free serial port that is not reserved by other applications or devices.
2. Attach your Suunto X9 firmly to the docking station with the display facing up. Plug the adapter in the docking station and the other end in an electric outlet. Plug the docking station in the serial port of the computer. Suunto X9 enters the PC Interface mode automatically.
3. Open Suunto Trek Manager.
4. Click *Connect to X9* icon on the bottom left window and Suunto Trek Manager displays the contents of your Suunto X9 (Tracks, Routes, MyPoints).
5. To transfer data between your Suunto X9 and Suunto Trek Manager, select an item and click *Download selected item(s) to folder* icon on the bottom left window. The selected item is placed in the Downloaded folder in the Local Data Window. You can now view it in the map window, add waypoints and alarm points.
6. When you have transferred the files to your PC, you can delete them from the Suunto X9 memory with Suunto Trek Manager and make room for new log files.

For further information on uploading routes, see the Suunto Trek Manager Help in the Help menu.

6.4.2. Local Data window (2)



The toolbar on the top of the Local Data window contains five normal icons and a menu icon:

- **Draw / Focus:** With this icon you can draw routes on the map. When you hold your left mouse button you can also scroll the map with your mouse.
- **Create route with one point:** With this icon you can create a route that has one waypoint. The route appears in the Information window where you can edit the coordinates and other data.
- **Delete selected item:** First select the items you want and then click on this icon to delete them from the STM memory.
- **Search:** This icon is useful if you have a large database and want to find a specific file quickly. Click on the icon, type the name of the file in the Search box and the file appears in the Local Data window.
- **Send selected to device:** With this icon you can transfer data from STM to your Suunto X9.

When you click the menu icon on the right side of the toolbar, the following menu opens. The availability of the menu functions depends on the selected file or folder.

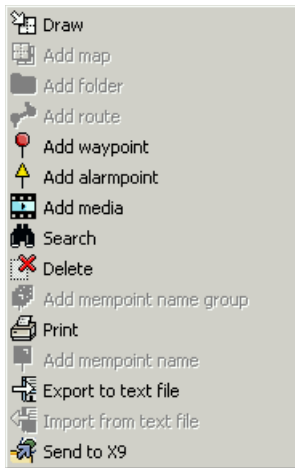

Draw: Explained along with the other icons of the Local Data window.

- Add map:** Add a map in the selected folder.
- Add folder:** Add a new sub-folder in the selected folder.
- Add route:** Create a new route in the selected folder.
- Add waypoint:** Add new waypoints in the selected folder or route.
- Add alarmpoint:** Add alarm points in the selected folder or route.
- Add media:** Add pictures, movies and audio files in the selected folder, tracks, waypoints, or routes.
- Search:** Explained along with the other icons of the Local Data window.
- Delete:** Delete the selected file or folder
- Add mempoint name group:** Add a new mempoint name group.
- Print:** Print the selected map or route.
- Add mempoint name:** Add a new mempoint name in an existing group.
- Export to text file:** Export a route to a new location.
- Import from text file:** Import a route from a text file to the selected folder.
- Send to X9:** Download the selected file or folder in the Suunto X9 memory.

6.4.3. Map window (3)



The toolbar on the top of the Map window a variable number of icons depending on your selections:

- **2D / 3D view:** With this icon you can display the routes either in 2D or 3D format
- **Create route and add points from map:** Click on this icon to create a new route. Then click on the Map window to add the waypoints or add their coordinates in the Information window.
- **Add waypoint to drawn route:** Click on this icon and then a location on the Map window to add a waypoint to the route. Additionally, you can specify the coordinates of the waypoint manually in the Information window.
- **Add alarm point to drawn route:** Click on this icon and then a location on the Map window to add an alarm point to the route.
- **Add point to folder:** Click on this icon to create a singular point that is not part of a route.
- **Add alarm point to folder:** Click on this icon to create a singular alarm point that is not part of a route.
- **Print map as it is now:** With this icon you can print the map in the map window.
- **Zooming mode:** With this icon you can zoom in an out for a more in-depth or general look. Use the left mouse button to zoom in and the right to zoom out.
- **Calibrate loaded map:** With this icon you can calibrate the currently visible map by setting a minimum of 2 known points, which you can set from a map or with your Suunto X9. The more reference points you provide the more accurate the measurements are.

6.4.4. Profiles window (4)



In this window you can view your altitude profiles and exact speed details as graphs. The toolbar on the top of the Profiles window contains three icons:

Time: With this icon you can view the information by time periods.

Distance: With this icon you can view the information by distances.

Zoom: With this icon you can zoom in and out for a more in-depth or general look.

6.4.5. Information window (5)

This window displays the detailed information on the routes, waypoints, settings etc. you have activated in other windows.

6.4.6. SuuntoSports window (6)

From here you can easily access the SuuntoSports.com website. You can also upload your tracks, routes and waypoints from the Local Data window, by dragging and dropping selected items. In SuuntoSports.com you can share them with other community members.

7. SUUNTOSPORTS.COM

SuuntoSports.com is an Internet community for all Suunto sports instrument users. It is a service that adds a new dimension to your sport and to the way in which you use your sports instrument. In SuuntoSports you can share your best experiences and the data measured during your activities with other sports participants. You can compare your performance with other Suunto users and learn from their activities. You can also download route coordinates and other useful and interesting location information published by Suunto and other Suunto X9 users.

SuuntoSports.com membership is free and open for all sports participants. However, to be able to send your data to SuuntoSports, you need a Suunto sports instrument to record the data. You will also need the PC software delivered with the product to transfer the data from your PC to SuuntoSports. Before becoming a registered member, you can also log in as a guest to check what SuuntoSports.com has to offer.

7.1. GETTING STARTED

To join SuuntoSports.com:

1. Install Suunto Trek Manager and ensure that your computer is connected to the Internet.

2. Click the *SuuntoSports.com* text  in the SuuntoSports.com window, located in the lower left corner of Suunto Trek Manager.

3. Click  to open the SuuntoSports.com registration page.

4. Click *Register* and follow the instructions to become a member and to register your Suunto X9. After the registration, you will automatically enter the SuuntoSports.com home page that introduces the site structure and functional principles. If needed, you can update your personal and equipment profiles in the My Suunto section. You can also enter SuuntoSports directly from www.suuntosports.com.

NOTE: *SuuntoSports.com is continuously developed and its content is subject to change.*

7.2. SECTIONS

SuuntoSports.com includes three sections for different levels of privacy. My Suunto is your personal area that other users do not have access to, Communities includes functions for groups, and Sports Forums contain information that members have published for all SuuntoSports visitors. This is a short description of the functions and basic principles of SuuntoSports. To learn about the functions and activities in detail, visit the site, try them and, if needed, use the step-by-step instructions that you find in the Help. The Help is available on each page and its icon is located on the right side of the bar that divides the screen.

The information published on SuuntoSports.com contains internal links that help your navigation within the site. For example, if you view a resort description, you can follow the links and view the personal information of the one who sent the resort information and the logs and travel reports related to the resort.

SuuntoSports.com offers several possibilities for searching for information on the website. You can search for groups, members, resorts, logs or just type in your own keywords to find what you need.

7.3. MY SUUNTO

My Suunto contains your personal information. You can write an introduction of yourself to other members, register your wristop computer, list your sports activities, and manage your membership profile. When you upload Suunto X9 logs to SuuntoSports.com with Suunto Trek Manager, they are displayed on your My Suunto front page. You can decide whether you want to make your logs public to all members, to limited groups or to keep them just for your own use. In My Suunto, you can also compare your logs with the ones that the others have published.

My Suunto section contains a personal event calendar that helps you plan your activities and keep a logbook of your training, development and favorite locations. You can also write travel reports of your activities, attach logs and photos, and publish them for other SuuntoSports members to admire.

7.4. COMMUNITIES

Communities are meeting places for smaller groups of SuuntoSports members. In the Communities section, you can create and manage communities and search for other communities. For example, you can create a community for all your friends with similar interests, and share your logs and results, discuss and plan activities. The information

published in a community is only visible to the members of the community. Communities can be either open or closed. To participate in the activities of a closed community, you first have to be invited or you have to apply for membership and be accepted.

All communities have a home page that lists the latest group activities such as news, discussions, events and recent logs. Community members can also use group-specific bulletin boards and calendars, create their own link lists and group activities. All registered SuuntoSports users become automatically members of the 'World of SuuntoSports' community.

7.5. SPORT FORUMS

Suunto users are active in many different sports. SuuntoSports.com has several Sports Forums that collect information to inform and inspire participants of these activities. All forums include sport-specific news, bulletin boards, event calendars, ranking lists and discussions. In the forums you can suggest links to sports-related websites and read travel reports written by other members.

Sport forums introduce interesting locations and resorts related to different sports. You can rank the resorts and suggest your own favorites. You can also view ranking lists from the SuuntoSports database by your own criteria, for example, the members who have visited the highest places, collected the most vertical climb or published the biggest number of logs, the communities with the most members, etc.

The information recorded with the Suunto X9 is shared in the Cross Sports forum, the area for all outdoor and endurance sports activities. In the Cross Sports forum and in the communities you can find routes created and published by other Suunto X9 users and download them for your personal use. Suunto also plans to publish coordinate information on interesting locations worldwide in the Cross Sports forum.

8. TECHNICAL SPECIFICATIONS

General

- Operating Temperature -20 °C to +60 °C/-5 °F to +140 °F
- Storage Temperature -30 °C to +60 °C/-22 °F to +140 °F
- Weight 76 g
- Water-resistant to 10 bar according to ISO 2281 standard
- Mineral crystal glass
- Rechargeable battery
- Docking station

Charger

- PC interface with a serial connector
- 240 V or 110 V depending on area of purchase
- Cigarette lighter charger 12V (optional accessory)

Memory

- 50 routes (each route can include up to 50 points)
- 500 waypoints
- 25 tracks (max. 8000 track points)

Barometer

- Display range 300 to 1100 hPa / 8.90 to 32.40 inHg
- Resolution 1hPa / 0.05 inHg

Altimeter

- Display range -500 m to 9000 m / -1500 ft to 29500 ft
- Resolution 1 m / 3 ft
- Thermometer
- Display range -20°C to +60°C/-5°F to +140°F
- Resolution 1°C / 1°F

3D Compass

- Resolution 1°

GPS

- Resolution 1 m / 3 ft
- 12 channels

9. GPS DATUM LIST

Suunto X9 offers the use of several different GPS datums that can be activated with the Suunto Trek Manager software with the help of the PC interface. Here is the list of available GPS datums and the number codes used in the activation process

For information about activating GPS datums, refer to Suunto Trek Manager.

For information about setting the correct GPS datum, see section 3.2.5. Units.

Number	Name	Description (Datum)
000	ADI-M	Mean Solution (Ethiopian and Sudan)
001	ADI-E	Burkina Faso
002	ADI-F	Cameroon
003	ADI-A	Ethiopia
004	ADI-C	Mali
005	ADI-D	Senegal
006	ADI-B	Sudan
007	AFG	Somalia
008	ARF-A	Botswana
009	ARF-H	Burundi
010	ARF-B	Lesotho
011	ARF-C	Malawi
012	ARF-D	Swaziland
013	ARF-E	Zaire
014	ARF-F	Zambia
015	ARF-G	Zimbabwe
016	ARS-M	Mean Solution (Kenya and Tanzania)
017	ARS-A	Kenya
019	PHA	Djibouti
020	BID	Guinea-Bissau
021	CAP	South Africa
022	CGE	Tunisia
023	DAL	Guinea
024	EUR-F	Egypt

025	EUR-T	Tunisia
026	LEH	Ghana
027	LIB	Liberia
028	MAS	Eritrea
029	MER	Morocco
030	MIN-A	Cameroon
031	MIN-B	Nigeria
032	MPO	Gabon
033	NSD	Algeria
034	OEG	Old Egypt
035	PTB	Mean Solution (Burkina Faso and Niger)
036	PTN	Congo
037	SCK	Namibia
038	SRL	Sierra Leone
039	VOR	Algeria
040	AIN-A	Bahrain Island
041	AIN-B	Saudi Arabia
042	BAT	Sumatra
043	EUR-H	Iran
044	HKD	Hong Kong
045	HTN	Taiwan
046	IND-B	Bangladesh
047	IND-I	India and Nepal
048	INF-A	Thailand
049	ING-A	Vietnam
050	ING-B	Con Son Island (Vietnam)
051	INH-A1	Thailand (1997)
052	IDN	Indonesia
053	KAN	Sri Lanka
054	KEA	West Malaysia and Singapore
055	KGS	Korean Geodetic System
056	NAH-A	Masirah Island (Oman)

057	NAH-B	United Arab Emirates
058	NAH-C	Saudi Arabia
059	FAH	Oman
060	QAT	Qatar
061	SOA	Singapore
062	TIL	Brunei and East Malaysia (Sarawak and Sabah)
063	TOY-M	Mean Solution (Japan, Okinawa and South Korea)
064	TOY-A	Japan
065	TOY-C	Okinawa
066	TOY-B	South Korea
067	AUA	Australia and Tasmania (Australian Geodetic 1966)
068	AUG	Australia and Tasmania (Australian Geodetic 1984)
069	EST	Estonia
070	EUR-M	Mean Solution (Europe 1950)
071	EUR-A	Western Europe (1950)
072	EUR-E	Cyprus
073	EUR-G	England, Channel Islands, Scotland and Shetland Islands
074	EUR-K	England, Ireland, Scotland and Shetland Islands
075	EUR-B	Greece
076	EUR-I	Italy (Sardinia)
077	EUR-J	Italy (Sicily)
078	EUR-L	Malta
079	EUR-C	Finland and Norway
080	EUR-D	Portugal and Spain
081	EUS	Mean Solution (European 1979)
082	HJO	Iceland
083	IRL	Ireland
084	OGB-M	Mean Solution (England, Isle of Man, Scotland, Shetland Islands and Wales)
085	OGB-A	England
086	OGB-B	England, Isle of Man and Wales
087	OGB-C	Scotland and Shetland Islands

088	OGB-D	Wales
089	MOD	Sardinia
090	SPK-A	Hungary
091	SPK-B	Poland
092	SPK-C	Czechoslovakia
093	SPK-D	Latvia
094	SPK-E	Kazakhstan
095	SPK-F	Albania
096	SPK-G	Romania
097	CCD	Czechoslovakia
098	CAC	Mean Solution (Florida and Bahamas)
099	NAS-C	Mean Solution (CONUS)
100	NAS-B	Western USA
101	NAS-A	Eastern USA
102	NAS-D	Alaska (excluding Aleutian islands)
103	NAS-V	Aleutian islands (East of 180deg W)
104	NAS-W	Aleutian islands (West of 180deg W)
105	NAS-Q	Bahamas (excluding San Salvador Island)
106	NAS-R	San Salvador Island
107	NAS-E	Canada Mean Solution (including Newfoundland)
108	NAS-F	Alberta and British Columbia
109	NAS-G	Eastern Canada
110	NAS-H	Manitoba and Ontario
111	NAS-I	NW Territories and Saskatchewan
112	NAS-J	Yukon
113	NAS-O	Canal Zone
114	NAS-P	Caribbean
115	NAS-N	Central America
116	NAS-T	Cuba
117	NAS-U	Greenland (Hayes Peninsula)
118	NAS-L	Mexico
119	NAR-A	Alaska (excluding Aleutian Islands)

120	NAR-E	Aleutian Islands
121	NAR-B	Canada
122	NAR-C	CONUS
123	NAR-H	Hawaii
124	NAR-D	Mexico and Central America
125	BOO	Columbia
126	CAI	Argentina
127	CHU	Paraguay
128	COA	Brazil
129	PRP-M	Mean Solution (Bolivia, Chile, Columbia, Ecuador, Guyana, Peru and Venezuela)
130	PRP-A	Bolivia
131	PRP-B	Northern Chile (near 19deg S)
132	PRP-C	Southern Chile (near 43deg S)
133	PRP-D	Colombia
134	PRP-E	Ecuador
135	PRP-F	Guyana
136	PRP-G	Peru
137	PRP-H	Venezuela
138	HIT	Southern Chile (near 53deg S)
139	SAN-M	Mean Solution
140	SAN-A	Argentina
141	SAN-B	Bolivia
142	SAN-C	Brazil
143	SAN-D	Chile
144	SAN-E	Colombia
145	SAN-F	Ecuador (excluding Galapagos Islands)
146	SAN-J	Baltra, Galapagos Islands
147	SAN-G	Guyana
148	SAN-H	Paraguay
149	SAN-I	Peru
150	SAN-K	Trinidad and Tobago

151	SAN-L	Venezuela
152	ZAN	Suriname
153	AIA	Antigua, Leeward Islands
154	ASC	Ascension Island
155	SHB	St. Helena Island
156	BER	Bermuda Islands
157	DID	Deception Island, Antarctica
158	FOT	Nevis, St. Kitts, Leeward Islands
159	GRA	Faial, Graciosa, Pico, Sao Jorge and Terceira Islands (Azores)
160	ISG	South Georgia Islands
161	LCF	Cayman Brac Island
162	ASM	Montserrat, Leeward Islands
163	NAP	Trinidad and Tobago
164	FLO	Corvo and Flores Islands (Azores)
165	PLN	Canary Islands
166	POS	Porto Santo and Madeira Islands
167	PUR	Puerto Rico and Virgin Islands
168	QUO	South Greenland
169	SAO	Sao Miguel, Santa Maria Islands (Azores)
170	SAP	East Falkland Island
171	SGM	Salvage Islands
172	TDC	Tristan Da Cunha
173	ANO	Cocos Islands
174	GAA	Republic of Maldives
175	IST	Diego Garcia
176	KEG	Kerguelen Island
177	MIK	Mahe Island
178	REU	Mascarene Island
179	AMA	American Samoa Islands
180	ATF	Iwo Jima
181	TRN	Tern Island
182	ASQ	Marcus Island

183	IBE	Efate and Erromango Islands
184	CAO	Phoenix Islands
185	CHI	Chatham Islands (New Zealand)
186	GIZ	Gizo Island (New Georgia Islands)
187	EAS	Easter Islands
188	GEO	New Zealand
189	GUA	Guam
190	DOB	Guadalcanal Island
191	JOH	Johnston Island
192	KUS	Caroline Islands, Fed.States of Micronesia
193	LUZ-A	Philippines (excluding Mindanao Island)
194	LUZ-B	Mindanao Island
195	MID	Midway Islands
196	OHA-M	Mean Solution (Old Hawaiian)
197	OHA-A	Hawaii
198	OHA-B	Kauai
199	OHA-C	Mau
200	OHA-D	Oahu
201	PIT	Pitcairn Islands
202	SAE	Espirito Santo Island
203	MVS	Viti Levu Island (Fiji Islands)
204	ENW	Marshall Islands
205	WAK	Wake Atoll
206	BUR	Bungka and Belitung Islands
207	CAZ	Camp McMurdo Area, Antarctica
208	EUR-S	Iraq, Israel, Jordan, Lebanon, S. Arabia and Syria
209	GSE	Kalimantan (Indonesia)
210	HEN	Afghanistan
211	HER	Former Yugoslavia
212	IND-P	Pakistan
213	PUK	Russia
214	TAN	Madagascar

215	VOI	Tunisia/Algeria
216	VOI-2	Tunisia/Algeria
217	YAC	Uruguay
218	RT90	Sweden
254	KKJ	Kartta Koordinaatisto Järjestelmä, Finland
255	WGS84	Global WGS84 coordinate system (This is the default datum and the most widely used degree-based coordinate system.)

10. LOCAL GRID LIST

Suunto X9 offers the use of several different local grids that can be activated with the Suunto Trek Manager software with the help of the PC interface. Here is the list of available local grids and the number codes used in the activation process.

You can activate grids with Suunto X9 or Suunto Trek Manager.

For information about setting the correct local grid, see section 3.2.5. Units.

Name	Description
Finnish	Finnish National grid KKJ 27
Swedish	Swedish national map projection RT 90
British	British National grid
Swiss	Swiss National grid
Irish	Irish National grid
NZTM	New Zealand Transverse Mercator Projection
Dutch	Royal Dutch grid
BNM M28	Austria Area grid M28
BNM M31	Austria Area grid M31
BNM M34	Austria Area grid M34

11. GLOSSARY

Alarm point	Position coordinates of a specific point on a route or in the MyPoints function that you can use, for example, to warn you about rocks and other hazards.
Altitude difference (dif)	Altitude difference between your current position and the next waypoint in the unit of your choice.
Altitude to finish (atf)	Total amount of ascent from the current position to the last waypoint.
Bearing (bea)	Compass direction from your current position to a destination.
Cross Track Error (xte)	This is the shortest distance from your current location to the straight line connecting the waypoints of the route.
Datum	A datum is a mathematically defined reference surface that approximates the shape of the earth, and enables calculations such as position and area to be carried out in a consistent and accurate manner. Every map has a datum or metric grid. You have to set your Suunto X9 to the correct datum/grid for it to function properly with the map.
Distance from start (dfs)	Traveled distance from the start point.
Distance to finish (dtf)	Distance from the current location to the last waypoint on the route (via each waypoint).
Distance to waypoint (dtw)	Distance to either the next or the active waypoint or to a My point depending on the chosen navigation method.
Estimated Time of Arrival (eta)	Estimated arrival time to the last waypoint based on the current speed.
Estimated Time Enroute (ete)	Estimated travel time to your current destination based on the current speed.
Global Positioning System (GPS)	Satellite tracking system.
Grid	A grid system is a set of lines that cross each

other at right angles on a map. Grid systems allow you to locate or report on a specific point on the map.

Heading (hea)	Compass direction on the present course.
Latitude	Angular distance North or South of the Equator.
Longitude	Angular distance West or East of the prime meridian.
Navigation	Traveling between two locations on a route with knowledge of the current position in relation to the route.
Position	Exact map coordinates of a given position.
Time of Sunrise (tsr)	Time of sunrise based on the current GPS position.
Time of Sunset (tss)	Time of sunset based on the current GPS position.
Time to Waypoint (ttw)	Estimated travel time to the next waypoint based on the current speed.
UTC offset	UTC means Universal Time, Coordinated. There are 25 standard time zones around the world that are all an integer offset of hours to UTC-time. If UTC-time is 12:00 (Noon/PM), then people having offset +5 hours, have local time 17:00 (or 5:00 PM). There are also some countries/places not using the standard time zones, they might be e.g. 5 hours and 45 minutes ahead of UTC.
Universal Transverse Mercator (UTM)	A grid system where the world is divided into 60 north-south zones, each covering a strip 6° wide in longitude.
Waypoint	Position coordinates on a course stored in the Suunto X9 memory.
WGS 84	WGS-84 (Geodetic, 1984) is an international reference system (map datum) which defines the shape of an earth ellipsoid, its angular velocity, mass, and gravity.

12. DISCLAIMERS

12.1. USER'S RESPONSIBILITY

Do not use Suunto X9 as the only navigation aid. Use all available navigation aids such as charts, compass, visual sightings etc. and compare them with the Suunto X9 navigation information. Make sure all conflicting information is resolved before continuing with navigation.

This instrument is intended for recreational use only. Do not use this instrument for obtaining measurements that require professional or industrial precision.

12.2. COPYRIGHT, TRADEMARK AND PATENT NOTICE

This publication and its contents are proprietary to Suunto Oy and are intended solely for the use of its clients to obtain knowledge and key information regarding the operation of Suunto X9 products.

Its contents shall not be used or distributed for any other purpose and/or otherwise communicated, disclosed or reproduced without the prior written consent of Suunto Oy.

Suunto, Suunto X9s and their logos are all registered or unregistered trademarks of Suunto Oy. All rights are reserved.

While we have taken great care to ensure that information contained in this documentation is both comprehensive and accurate, no warranty of accuracy is expressed or implied. Its content is subject to change at any time without notice. You can always download the latest version of this documentation in www.suunto.com.

This product is protected by US 6,549,850 patent. US patent application no. 09/769,851 is pending. Other patents have been applied for.

12.3. CE

The CE mark is used to mark conformity with the European Union EMC directive 89/336/EEC and 99/5/EEC.

12.4. LIMITS OF LIABILITY AND ISO 9001 COMPLIANCE

If this product should fail due to defects in materials or workmanship, Suunto Oy will, at its sole option, repair or replace it with new or rebuilt parts, free of charge, for two (2) years from the date of its purchase. This warranty is only extended to the original purchaser and only covers failures due to defects in materials and workmanship that occur during normal use while in the period of the warranty.

It does not cover battery, battery replacement, damage or failures resulting from accident, misuse, neglect, mishandling, alteration or modifications of the product, or any failure caused by operation of the product outside the scope of its published specifications, or any causes not covered by this warranty.

There are no express warranties except as listed above.

The client can exercise the right to repair under the warranty by contacting Suunto Oy's Customer Service department to obtain a repair authorization.

Suunto Oy and its subsidiaries shall in no event be liable for any incidental or consequential damages arising from the use of or inability to use the product. Suunto Oy and its subsidiaries do not assume any responsibility for losses or claims by third parties that may arise through the use of this device.

Suunto's Quality Assurance System is certified by Det Norske Veritas to be ISO 9001 compliant in all SUUNTO Oy's operations (Quality Certificate No. 96-HEL-AQ-220)

12.5. AFTER SALES SERVICE

If a claim under warranty appears to be necessary, return the product, freight prepaid, to your Suunto dealer who is responsible for having your product repaired. Include your name, address, proof of purchase and/or service registration card, as required in your country. The claim will be honored and the product repaired or replaced at no charge and returned in what your Suunto dealer determines a reasonable amount of time, provided all necessary parts are in stock. All repairs that are not covered under the terms of this warranty will be made at the owner's expense. This warranty is non-transferable from the original owner.

If it is not possible to contact your Suunto dealer, contact your local Suunto distributor for further information. You can locate your local Suunto distributor in www.suunto.com.

12.6. DISCLAIMER

Since the GPS satellites and the delivery system are neither owned nor maintained by Suunto, Suunto takes no responsibility for possible malfunctions, changes in positioning quality or the discontinuity of the GPS service in the future. Suunto will not reclaim products because of changes in the GPS service.

This device complies with Part 15 of the FCC limits for class B digital devices. This equipment generates, uses, and can radiate radio frequency energy and, if not installed or used in accordance with the instructions may cause harmful interference to

radio communications. There is no guarantee that interference will not occur in a particular instance. If this equipment does cause harmful interference to other equipment, try to correct the problem by relocating the equipment.

Consult an authorized Suunto dealer or other qualified service technician if you cannot correct the problem. Operation is subject to the following conditions:

(1) This device cannot cause harmful interference.

(2) This device must accept any interference received, including interference that may cause undesired operation.

Repairs should be made by authorized Suunto service personnel. Unauthorized repairs will void warranty.

www.suunto.com

Made in Finland