

# INSTRUCTION MANUAL

**Spyder**





Fig. 1.1 Quick reference guide

# **SUUNTO SPYDER**

## **ADVANCED COMPUTER WATCH**

The Suunto Spyder Advanced Computer Watch is a true multi-level dive computer. The Spyder features:

### Advanced Watch Functions

- complete calendar clock, also during diving
- stopwatch with elapsed time and split time measurement
- alarm clock

### Advanced Dive Computer Functions

- personal adjustability
- altitude adjustability
- continuous decompression
- ascent rate indicator and warnings
- visual and audible alarms
- complete memory capabilities including a 36-hour profile memory
- planning mode for dive planning before and between dives
- user definable display field
- electroluminescent illumination
- battery power indicator and low battery warning
- PC-Interface capability

All the advanced features of the Spyder are bound in a durable high-quality metal case.

# MENUS AND OPERATION

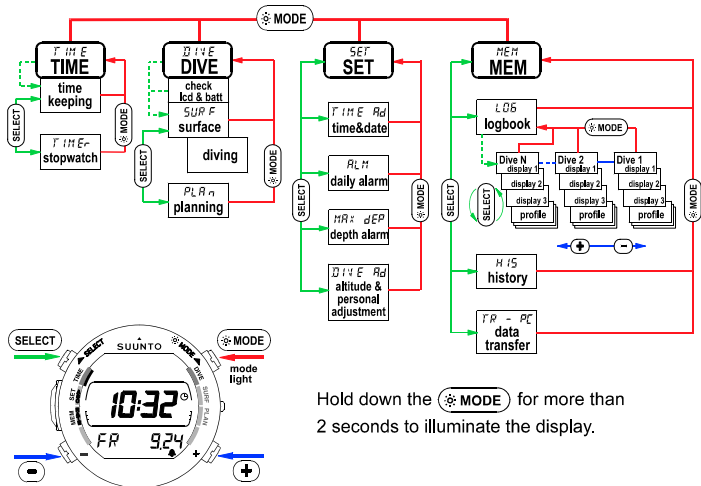

Hold down the **MODE** for more than 2 seconds to illuminate the display.

Fig. 1.2 Menus of the Spyder

## **DEFINITION OF WARNINGS, CAUTIONS AND NOTES**

Throughout this manual, special references are made when deemed important. Three classifications are used to separate these references by their order of importance.

**WARNING** is used in connection with a procedure or situation that may result in serious injury or death.

**CAUTION** is used in connection with a procedure or situation that will result in damage to the product.

**NOTE** is used to emphasize important information.

## **COPYRIGHT, TRADEMARK AND PATENT NOTICE**

This instruction manual is copyrighted and all rights are reserved. It may not, in whole or in part, be copied, photocopied, reproduced, translated, or reduced to any media without prior written consent from SUUNTO.

SUUNTO, Spyder, Lux, ACW (Advanced Computer Watch), ACW Dive Log, User Definable Display Field, Continuous Decompression and their logos are all registered or unregistered trademarks of SUUNTO. All rights are reserved.

Patents have been issued or applied for one or several features of this product.

### **CE**

The CE mark is used to mark conformity with the European Union EMC directive 89/336/EEC. The SUUNTO dive instruments fulfill all the required EU directives.

### **ISO 9001**

SUUNTO Oy's Quality Assurance System is certified by Det Norske Veritas to be according to the ISO 9001 in all SUUNTO Oy's operations (Quality Certificate No. 96-HEL-AQ-220).

SUUNTO Oy does not assume any responsibility for losses or claims by third parties which may arise through the use of this device.

Due to continuous product development the Spyder is subject to change without notice.

## **WARNING!**

ONLY DIVERS TRAINED IN THE PROPER USE OF SCUBA EQUIPMENT SHOULD USE THE SPYDER! No dive computer can replace the need for proper dive training. Insufficient or improper training may cause diver to commit errors that may lead to serious injury or death.

## **WARNING!**

READ THIS MANUAL! Carefully read this instruction manual in its entirety, including Section 2, “For Your Safety“. Make sure that you fully understand the use, displays and limitations of the Spyder. Any confusion resulting from improper use of this device may cause diver to commit errors that may lead to serious injury or death.

## **WARNING!**

NOT FOR PROFESSIONAL USE! SUUNTO dive computers are intended for recreational use only. The demands of commercial or professional diving often expose the diver to depths and prolonged exposures including multiday exposures that tend to increase the risk of decompression sickness. Therefore, SUUNTO specifically recommends that the Spyder is not used for commercial or other severe diving activity.

## **WARNING!**

PERFORM PRECHECKS! Always check the Spyder before diving in order to ensure that all LCD segments are completely displayed, that the Spyder has not run out of battery power, and that the altitude and personal adjustment mode is correct.

## **WARNING!**

**USE BACK-UP INSTRUMENTS!** Make sure that you use back-up instrumentation including a depth gauge, submersible pressure gauge, timer or watch, and have access to decompression tables whenever diving with the Spyder.

## **WARNING!**

**NO DIVE COMPUTER WILL PREVENT THE POSSIBILITY OF DECOMPRESSION SICKNESS (DCS)!** All divers must understand and accept that there is no procedure or dive computer that will totally prevent the possibility of a decompression accident. For example, the individual physiological make up can vary within an individual from day to day. The dive computer cannot account for these variations. As an added measure of safety, you should consult a physician regarding your fitness before diving with the Spyder. Decompression sickness can cause serious injury or death.

## **CAUTION!**

**ENSURE THE WATER RESISTANCE OF THE DEVICE!** Ensure the water resistance of the device by servicing the push buttons and protective seals every two years. Avoid operating the push buttons unnecessarily underwater. Always check the water resistance of the device when replacing the battery. Moisture inside the device will seriously damage the unit. Battery replacement and other service activities should be done only by an authorized SUUNTO dealer or distributor.

# TABLE OF CONTENTS

1. INTRODUCTION .....	8
1.1 IMPORTANT INFORMATION .....	8
1.2 KEY FEATURES .....	10
1.3 FUNCTIONS AND THE USE OF THE PUSH BUTTONS .....	11
1.4 GETTING STARTED .....	12
1.5 METRIC AND IMPERIAL UNITS .....	13
2. FOR YOUR SAFETY .....	14
2.1 SAFETY PRECAUTIONS .....	14
3. TIME MODE .....	20
3.1 TIMEKEEPING DISPLAY .....	21
3.2 STOPWATCH .....	22
4. DIVING WITH THE SPYDER .....	24
4.1 USE OF PUSH BUTTONS AND WATER CONTACT .....	25
4.2 BEFORE DIVING .....	26
4.2.1 Activation, Prechecks and Battery Warning .....	26
4.2.2 Dive Planning .....	31
4.2.3 Example Dive - For Easy Learning .....	33
4.2.4 Presetting Displays and Alarms .....	33
4.3 DIVING .....	37
4.3.1 Basic Dive Data .....	37
4.3.2 Reverse No-decompression Time Bar Graph .....	38
4.3.3 Ascent Rate Indicator .....	39
4.3.4 Audible and Visual Alarms .....	41
4.3.5 Decompression dives .....	42



4.4	AT THE SURFACE .....	47
4.4.1	Surface Interval .....	47
4.4.2	Flying After Diving .....	49
4.5	HIGH ALTITUDE DIVES AND PERSONAL ADJUSTMENT .....	51
4.6	ERROR CONDITIONS .....	55
5.	SETTING MODE .....	56
5.1	SETTING TIME AND DATE .....	57
5.2	DAILY ALARM SETTING .....	59
5.3	DEPTH ALARM SETTING .....	61
5.4	ALTITUDE ADJUSTMENT AND PERSONAL ADJUSTMENT SETTING .....	62
6.	MEMORIES AND DATA TRANSFER .....	65
6.1	LOGBOOK AND DIVE PROFILE MEMORY .....	66
6.2	DIVE HISTORY MEMORY .....	71
6.3	DATA TRANSFER AND PC-INTERFACE .....	72
7.	CARE AND MAINTENANCE .....	74
7.1	CARE OF YOUR ADVANCED COMPUTER WATCH .....	74
7.2	MAINTENANCE .....	75
7.3	WATER RESISTANCE INSPECTION .....	76
8.	TECHNICAL DESCRIPTION .....	76
8.1	OPERATING PRINCIPLES .....	76
8.2	TECHNICAL SPECIFICATION .....	82
9.	WARRANTY .....	84
10.	GLOSSARY .....	86

## **1. INTRODUCTION**

Congratulations on your choice of the SUUNTO Spyder Advanced Computer Watch. The Spyder is a compact and most sophisticated dive instrument that will give you years of trouble-free and joyful diving. The Spyder Advanced Computer Watch will provide you with important information that you will need during, between, and after your dives.

### **1.1 IMPORTANT INFORMATION**

NEVER test the Spyder in a pressure chamber. Only authorized SUUNTO service personnel may test the Spyder and make test dives in a pressure chamber, as it requires special equipment and training.

#### **Battery**

Battery life of the Spyder is about 1.5 years when used as a watch. Diving, alarms and use of the backlight shorten the battery life. Note, that the battery loaded at the factory may discharge during the shipment and storage. Temperature affects the battery voltage. If the Spyder is stored at low temperatures (particularly below freezing point), the low battery warning may be displayed even though the battery has enough capacity in warmer conditions. The battery should be replaced only by an authorized SUUNTO dealer or distributor.

#### **Water Resistance**

This device will withstand the ingress of water at the static pressure of 20 ATM (200 m [660 ft]). Note, however, that dynamic pressure generated by movement underwater is greater than static pressure.

## **Depth Sensor**

The built-in depth sensor of the Spyder is a sophisticated precision instrument. The depth sensor cover may be opened only by an authorized SUUNTO dealer or distributor. NEVER try to open the cover yourself. Keep the area around the depth sensor clear from dirt, sand, dust or other substances. Rinse the device thoroughly with fresh water and dry it with a soft towel. Never use pins, needles or other objects to clean the depth sensor.

## **Water Contact**

The water contact controls the automatic activation of the Dive Mode, as well as the automatic return from the Dive Mode to the Time Mode. Contamination or dirt on the water contact may prevent these automatic operations. It is, therefore, important that the water contact is kept clean. The contact can be cleaned with fresh water and a soft pencil eraser.

NOTE: Water or moisture build-up around the water contact may cause the contact to activate automatically. This can happen, e.g., when washing your hands or sweating. If the water contact activates in the Time Mode, an ACW text will appear on display (see Fig. 4.2. b), and it will be shown until the water contact deactivates, or the Spyder enters the Dive Mode automatically. To save the battery power, you should deactivate the water contact by cleaning it and/or drying it with a soft towel.

Exposing the Spyder to great temperature changes may cause the Dive Mode to activate automatically. The Spyder will return to the normal display (timekeeping) 10 minutes after the water contact has dried. To save the battery power and also to enable the use of the timekeeping display, it is recommended to return to the normal display by using the push buttons.

## 1.2 KEY FEATURES

The Spyder Advanced Computer Watch has a built-in calendar clock, stopwatch and alarm clock.

The Spyder has complete dive computer features. It monitors and reports vital information such as your dive time, current depth, maximum depth, no-decompression time and ascent rate. It will give you visual and audible warnings, as required. Its built-in planning function allows you to plan dives before and between dives. The Spyder will also give you information you may need, if through carelessness or emergency you exceed the no-decompression limits for any dive.

The Spyder features versatile memory capabilities, including both detailed profiles and long-term historical data. It can interface with a PC, allowing for additional logbook features and dive simulation. The instrument can be adjusted for diving at different altitudes and to add a personal level of conservativeness if desired.

The case of the Spyder is made of a high-quality metal. The special monolithic case makes the Spyder water resistant and pressure responsive. The unique triple-gasket push buttons are especially designed to withstand water, pressure and dirt, and to ensure reliable operation under demanding conditions. The display is protected against damage by a mineral crystal, which can be easily replaced. A flexible extension strap allows the easy fastening of the device also on an exposure suit.

The Spyder is equipped with a sophisticated electroluminescent backlight

display, which does not significantly reduce battery life because of the highly energy-efficient system design and because the lamp goes off automatically after a few seconds from activation. The electroluminescent lamp will give excellent backlight quality in darkness and low ambient light conditions. The backlight is not visible during daylight.

### 1.3 FUNCTIONS AND THE USE OF THE PUSH BUTTONS

In the Spyder Advanced Computer Watch, there are four main modes (TIME, DIVE, SET, MEM) and 13 submodes (see Fig. 1.2). You can scroll through the modes using the push buttons. The mode indicator at the left or the right side and the mode text at the bottom of the display indicate the selected mode.

The Spyder is controlled with four push buttons as follows (see Fig. 1.3).

#### - **button**

To change from a main mode to another main mode press  .

To exit from a submode to a main mode press  .

To activate the electroluminescent backlight hold down  for more than two (2) seconds.

To accept the settings in the Setting Mode press  .

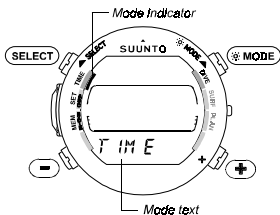

Fig. 1.3 The push buttons of the Spyder.

### **SELECT** - button

To select a submode press **SELECT**.

To select the active segment in the Setting Mode press **SELECT**.

To select the display in the Logbook Mode press **SELECT**.

### **+** and **-** buttons

To show the date or seconds in the time keeping display press **+** or **-**.

In the Setting Mode

press **+** to *increase* the value.

press **-** to *decrease* the value.

To operate the stopwatch see section 3.2, “Stopwatch“.

To select the dive in the Logbook Mode

press **+** to move forward,

press **-** to move backwards.

## **1.4 GETTING STARTED**

Before you start using the Spyder you must read and understand this manual in its entirety. Before your first actual dive it is of utmost importance that you read *Section 2*,

“For Your safety“, and *Section 4*, “Diving with the Spyder“. *Section 3*, “Time Mode“, teaches you how to use the clock functions of the Spyder. *Section 5*, “Setting Mode“, gives instructions on how to set the time, date, daily alarm and the time format in the clock, and the depth alarm and Altitude and Personal Adjustments in the dive computer. *Section 6*, “Memories and Data Transfer“ teaches how to access the memory functions and how to transfer the data from the Spyder to a PC. *Section 7*, “Care and Maintenance“, gives you detailed information about the care and maintenance of your Spyder, and the battery replacement. Finally, there is technical information in *Section 8*, and information on service and warranty in *Section 9*.

## 1.5 METRIC AND IMPERIAL UNITS

All examples in this manual are shown in metric units, including meters and °C. The corresponding imperial units are shown in brackets. The Spyder is also available in imperial units, i.e. feet and °F. THE UNITS CANNOT BE CHANGED BY THE USER.

### **WARNING!**

VERIFY THAT THE UNITS OF MEASURE, WHETHER METRIC OR IMPERIAL, ARE CORRECT BEFORE DIVING! Any confusion resulting from improper units may cause the diver to commit errors that may lead to serious injury or death.

## 2. FOR YOUR SAFETY

Do not attempt to use the Spyder without reading this instruction manual in its entirety, including all the warnings in the beginning of this manual and the entire section 2, “For Your Safety“. Make sure that you fully understand the use, displays and limitations of the Spyder. If you have any questions about the manual or the Spyder, contact your SUUNTO dealer before diving with the Spyder.

Always remember that **THE DIVER IS RESPONSIBLE FOR HIS OR HER OWN SAFETY!**

When used properly the Spyder is an outstanding tool for assisting properly trained, certified divers in planning and executing standard and multi-level sport dives within the described no-decompression limits. It is **NOT A SUBSTITUTE FOR CERTIFIED SCUBA INSTRUCTION** including training in the principles of decompression.

### 2.1 SAFETY PRECAUTIONS

#### Sharing the Spyder

#### **WARNING!**

THE SPYDER SHOULD NEVER BE TRADED OR SHARED BETWEEN USERS WHILE IT IS IN OPERATION! Its information will not apply to someone who has not been wearing it throughout a dive or sequence of repetitive dives. Its dive profiles must match that of the user. If it is left on the surface during any dive, it will give inaccurate information for subsequent dives. No



dive computer can take into account dives made without the computer. Thus any diving activity 48 hours prior to initial use of the computer may give misleading information, which may substantially increase the risk of decompression sickness and must be avoided.

## **Altitude and Personal Adjustments**

### **WARNING!**

**SET THE CORRECT ALTITUDE AND PERSONAL ADJUSTMENT MODES!** Failure to properly select the Altitude and Personal Adjustment Modes correctly will result in erroneous data and can greatly increase the risk of decompression sickness. More information about this is given in Section 4.5, “High Altitude Dives and Personal Adjustment“.

### **WARNING!**

**SET THE CORRECT ALTITUDE ADJUSTMENT MODE WHEN DIVING AT ALTITUDES GREATER THAN 700 M [2300 FT]!** When diving at altitudes greater than 700 m [2300 ft] the altitude adjustment feature must be correctly selected in order for the computer to calculate no-decompression status. Failure to select the Altitude Adjustment Mode correctly will result in erroneous data and can greatly increase the risk of decompression sickness.

## **WARNING!**

THE SPYDER IS NOT INTENDED FOR USE AT ALTITUDES GREATER THAN 2400 M [8000 FT]. Diving at altitudes above this limit may significantly increase the risk of decompression sickness.

### **Decompression Dives**

SUUNTO does not recommend this instrument to be used to conduct decompression dives. However, if through carelessness or emergency a diver exceeds the no-decompression limits on a dive, the Spyder will provide decompression information required for ascent. After this the Spyder will continue to provide subsequent interval and repetitive dive information.

## **WARNING!**

DO NOT USE THIS INSTRUMENT TO CONDUCT DIVES WITH NECESSARY DECOMPRESSION STOPS! SUUNTO does not recommend this instrument to be used to conduct these types of dives. Decompression Diving limits the divers ability to ascend directly to the surface and may substantially increase the risk of decompression sickness.

### **Emergency Ascents**

In the unlikely event that the Spyder malfunctions during a dive, follow the emergency procedures provided by your certified dive training agency or, alternatively, immediately ascend at a rate slower than 10 m/min [33 ft/min] to a depth between 3 and 6 meters [10 to 20 ft] and stay there as long as your air supply will safely allow.

## Higher Risk Dive Profiles

The user must understand that all decompression devices (decompression tables and/or dive computers) are based on mathematical models and that many experts are currently concerned that these models may not under certain conditions adequately describe the physiological phenomena. These conditions are presently identified as dives which incorporate the following:

- **REVERSE PROFILES** where the diver spends most of the dive at shallow depths and then descends to the maximum depth shortly before surfacing.
- **SAWTOOTH PROFILES** where the diver alternates between greater and shallower depths repeatedly throughout the dive.
- **CONSECUTIVE DIVES** where the diver performs repetitive dives to approximately the same maximum depth with only short surface intervals between dives. The risk of decompression sickness increases when depth and the number of repetitive dives increase and when the surface intervals are shortened.

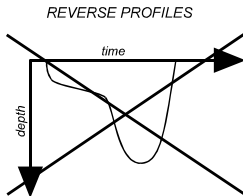

*Fig. 2.1 Reverse profiles.*

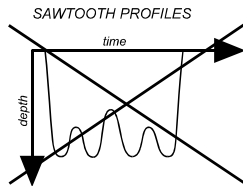

*Fig. 2.2 Sawtooth profiles.*

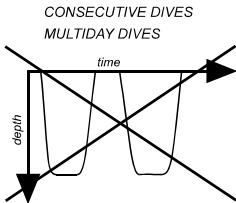

*Fig. 2.3 Consecutive dives, multiday dives.*

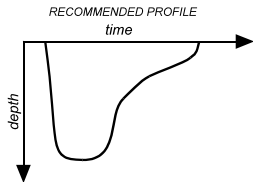

*Fig. 2.4 Recommended dive profile.*

- **MULTIDAY DIVES.** Repetitive dives performed during several consecutive days.
- **DECOMPRESSION DIVES.** Any dive during which the no-decompression limit has been exceeded or the diver is advised by the computer that he may not return directly to the surface.

### **Dive Computer Limitations**

While the Spyder is based on current decompression research and technology, the user/diver must realize that the computer cannot monitor the actual physiological functions of an individual diver. All decompression schedules currently known to the authors, including the U.S. Navy Tables, are based on a theoretical mathematical model which is intended to serve as a guide to reduce the probability of decompression sickness.

The mathematical model uses a fixed ascent rate of 10 m/min [33 ft/min] even at greater depths to reduce the build-up of microbubbles, which can grow larger and turn into harmful bubbles in a later phase of the dive. Therefore it is critical that a proper ascent rate is always used.

The reader/diver is forewarned that individual physiological differences, severe environmental conditions and pre-dive activities, especially those which tend to increase dehydration, may increase the risk of decompression sickness.

As a safety precaution SUUNTO recommends that divers using the Spyder should maintain no less than 5 to 10 minutes of no-decompression time remaining at all times during the dive. This is especially important for divers in poor physical condition, in cold water or other arduous conditions.

Historically divers have been advised to always include a margin of safety in their diving activities. SUUNTO supports these practices and strongly recommends that the diver makes the deepest portion of the dive near the beginning of the dive and gradually progress into shallower depth, allowing time for a 3 to 5 minute “safety stop“ at a depth range of 3 to 6 meters [10 to 20 ft]. This is believed to be effective in further reducing the risk of decompression sickness.

Furthermore, the reader/diver is advised that any dive carries some risk of decompression sickness and neither the authors, nor SUUNTO Oy will assume any responsibility or liability for accidents or injuries which might occur for any reason.

### **WARNING!**

**DO NOT USE THE SPYDER WITH NITROX MIXES!** The mathematical calculation model of the Spyder applies for use with standard breathing air only (approximately 21% oxygen and 79% nitrogen by volume). Therefore, using the Spyder for diving with “Nitrox“ or other mixed gases may lead to serious injury or death.

### 3. TIME MODE TIME

The Spyder has calendar clock, stopwatch and alarm clock functions. The calendar clock and the stopwatch are operated in the Time Mode (Fig. 3.1).

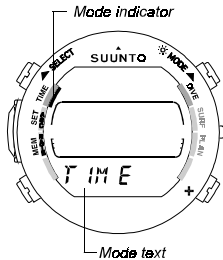

Fig. 3.2 The Time Mode is indicated by the TIME text and a mode indicator.

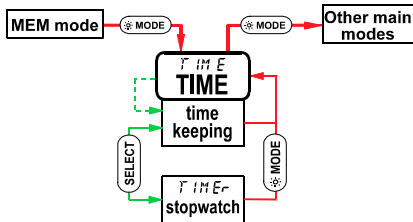

Fig. 3.1 The Time Menu

The mode is indicated in the display by the TIME text and the mode indicator (Fig. 3.2). The time and date and the daily alarm are set in the Setting Mode (see SECTION 5, “Setting Mode“).

### 3.1 TIMEKEEPING DISPLAY

The timekeeping display (Fig. 3.3) is the primary display of the Spyder. When the Time Mode is entered from other modes, the timekeeping display activates within two seconds, if no button is operated.

In other modes (except in the Diving or Stopwatch Modes), if no button is operated within 10 minutes, the Spyder beeps and returns to the timekeeping display automatically.

Either the date (Fig. 3.3 a) or the seconds of the current time (Fig. 3.3 b) are shown on the bottom line of the timekeeping display. Press the  $\oplus$  or  $\ominus$  button to select the desired display option. Next time when you enter the timekeeping display, the Spyder will show the selected option. The **TIMER** text blinks on the display if the stopwatch is running.

The display is illuminated by holding down the  $\otimes$  button for more than two seconds.

To set the time and date, refer to section 5.1, “Setting Time and Date”.

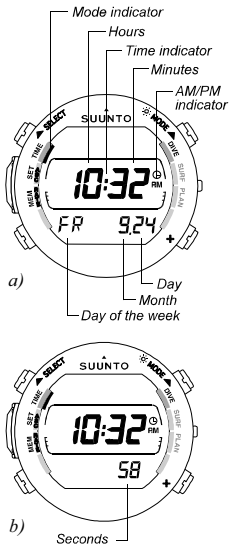

Fig. 3.3 The timekeeping display  
a) the date is displayed  
b) the seconds are displayed.

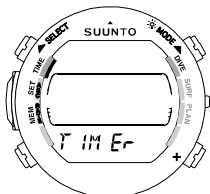

Fig. 3.4 The Stopwatch function is indicated by the *TIMER* text and a mode indicator:

When diving, the dive entry time and date is registered in the Logbook Memory. Remember always to check before diving that the time and date are correctly set, especially when traveling to different time zones.

### 3.2 STOPWATCH *TIMER*

The Stopwatch function is entered by pressing the **SELECT** button when the time keeping display is shown. The text *TIMER* at the bottom and the mode indicator (*TIME*) on the left side of the display indicate that you have entered the Stopwatch function (Fig. 3.4).

The stopwatch of the Spyder lets you measure elapsed time, split times and the times of two runners. The range of the stopwatch is 9 hours, 59 minutes, 59.9 seconds (Fig. 3.5). When the range is exceeded the computer watch gives a beep and returns to the time keeping display automatically.

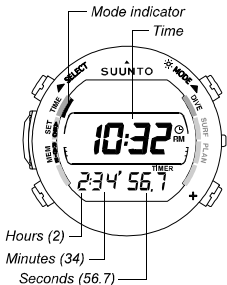



Fig. 3.5 The Stopwatch displays hours, minutes and seconds.



Use the **+** and **-** buttons to operate the elapsed time measurement, split time measurement or the times of two runners as follows:

***Elapsed time measurement***

- +** Start 
- +** Stop
- +** Restart
- +** Stop
- Clear

***Split time measurement***

- +** Start 
- Split
- Split release
- +** Stop
- Clear

***Times of two runners***

- +** Start 
- Split  
*(time of the first runner)*
- +** Stop
- Split release  
*(time of the second runner)*
- Clear

The stopwatch function is not available when diving or transferring data to a PC. Diving with the Spyder or data transfer will stop the stopwatch.

## 4. DIVING WITH THE SPYDER

This section contains instructions on how to operate the Spyder and interpret its displays. Each display has been carefully designed to provide important information you will need to plan your dive or dive series.

You will find that the Spyder is easy to use and read. Each display shows only the data relevant to that specific diving situation. You will also be able to preset the User Definable Display Field and depth and time alarms according to your personal preference.

The Spyder's dive functions are operated in the Dive Mode (Fig. 4.1).

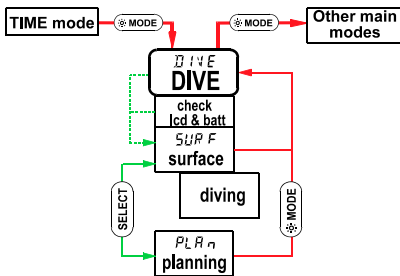

Fig. 4.1. The Dive Menu.

## 4.1 USE OF PUSH BUTTONS AND WATER CONTACT

The Dive Mode is controlled with the **MODE**, **SELECT**, and the **+** and **-** push buttons and with the water contact as follows (see also Section 1.3):

**Activation of the Dive Mode:** press the **MODE** button until the Dive Mode is indicated or immerse the Spyder in water below 0.45 m [1.5 ft] for five (5) seconds.

**Dive Planning:** in the Dive Mode, press the **SELECT** button.

**Return to Other Main Modes:** press the **MODE** button.

The water contact is located on the right side of the case (Fig 4.2 a). When submerged the contact is connected to the case by the conductivity of the water. Active water contact is indicated on display by the ACW-text (Fig 4.2 b). When the Spyder is submerged below 0.45 [1.5 ft] it goes into Dive Mode and the Surface or Diving Mode is automatically activated.

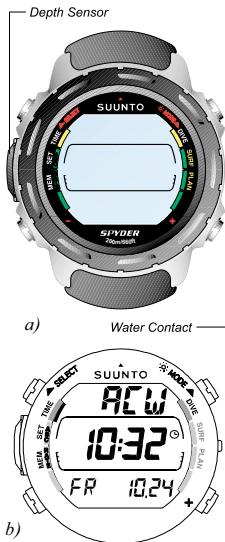



Fig. 4.2

a) The water contact and depth sensor.

b) Active water contact is indicated by the ACW-text.

Contamination or invisible marine growth may create an unwanted electric current between the water contact and the case. This may cause problems with the water contact: the Dive Mode may activate on its own, Spyder does not return to the time keeping display automatically, or the ACW-text remains on display. It is therefore important that the  Spyder is carefully washed in fresh water after the day's diving is completed. The contact can be cleaned with a soft pencil eraser.

## 4.2 BEFORE DIVING

### 4.2.1 Activation, Prechecks and Battery Warning

The Spyder is always ready for diving and will activate if submerged. However, it is necessary to turn on the Dive Mode before diving to check the altitude or personal adjustment settings, battery warning, etc. This is done by pressing the  button or either by immersing the Spyder in at least 0.45 m [1.5 ft] depth for 5 seconds.

The Dive Mode is indicated by the DIVE text and mode indicator on the right side of the display (Fig. 4.3). Next, all display elements will

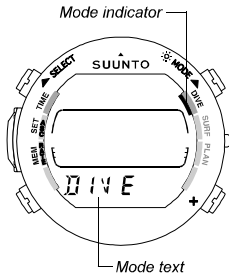

*Fig. 4.3 Startup I. The Dive Mode is indicated by the DIVE text and mode indicator.*

turn on showing mostly figure 8's and graphical elements (Fig. 4.4). A few seconds later the battery power indicator is shown and the backlight and the buzzer are activated (Fig. 4.5, display a, b, c, d or e, depending on the battery voltage). Next, the screen will display SURF for Surface Mode (Fig. 4.6) and a few seconds later it will show the Ready display confirming that the activation is complete (Fig. 4.7).



Fig. 4.4 Startup II. All segments shown.

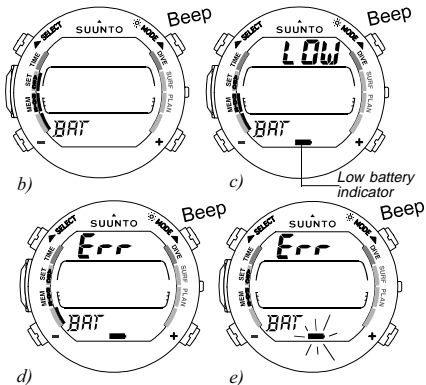
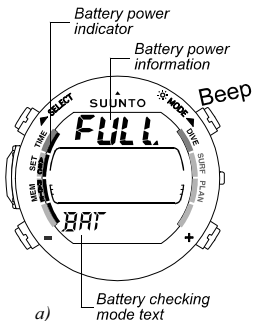
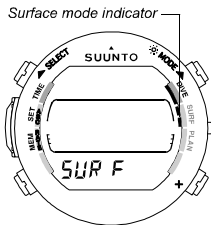

Fig. 4.5 Startup III. The battery power indicator.



*Fig 4.6 Startup IV. The Surface Mode is indicated by the SURF text and mode indicators.*

At this time, perform your precheck making sure that:

- the Spyder operates and provides a complete display
- the low battery indicator is not on
- the altitude and personal adjustment settings are correct
- the instrument displays correct units
- the instrument displays correct temperature and depth (0,0 m [0 ft]).
- the buzzer beeps
- you have preset desired displays on the User Definable Display Field (See section 4.2.4 “Presetting Displays and Alarms”).

The Spyder is now ready for diving.

NOTE: The surface interval time does not run before the first dive.

After activation of the Dive Mode or after diving, the Spyder will automatically switch to show the time keeping display within 10 minutes to conserve the battery power, if you do not press any buttons. However, the dive computer functions will remain active until it has calculated

that all residual nitrogen has off-gassed. This may take up to 48 hours, as described in Section 8.1, “Operating Principles“. SUUNTO recommends that you always turn on the Dive Mode before diving to check the settings, battery warning, etc.

## High Altitude Diving and Personal Adjustment

### WARNING!

SET THE CORRECT ALTITUDE AND PERSONAL ADJUSTMENT MODES! Failure to properly select these modes correctly will result in erroneous data and can greatly increase the risk of DCS. See Section 4.5, “High Altitude Dives and Personal Adjustment“.

### WARNING!

THE SPYDER IS NOT INTENDED FOR USE AT ALTITUDES GREATER THAN 2400 m [8000 ft]! Diving at altitudes above this limit may significantly increase the risk of DCS. See Section 4.5, “High Altitude Dives and Personal Adjustment“.

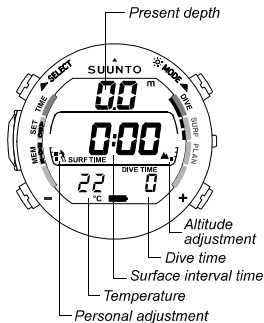

Fig. 4.7 Ready display. The depth and dive time are zeros (as no dives have yet been made), the surface interval time is 0 hours 0 minutes and the temperature is 22°C [72°F].

## Battery Power Indicator and Low Battery Warning

The Spyder has an unique graphic Battery Power Indicator designed to give advance notice of an impending need to change the battery.

The Battery Power Indicator can always be seen, when the Dive Mode is activated. The electroluminescent backlight will be on during the battery check. The following Table 4.1 and Figure 4.5 show the various warning levels.

<i>Display</i>	<i>Operation</i>	<i>Figure</i>
<i>All segments + FULL</i>	<i>Normal</i>	<i>4.5 a</i>
<i>Three segments</i>	<i>Normal</i>	<i>4.5 b</i>
<i>Two segments + LOW</i>	<ul style="list-style-type: none"><li>- battery power is getting low</li><li>- battery replacement is recommended</li><li>- the battery symbol is displayed</li><li>- the backlight is disabled</li></ul>	<i>4.5 c</i>
<i>One segment + Err</i>	<ul style="list-style-type: none"><li>- battery replacement is recommended</li><li>- the battery symbol is displayed</li><li>- the backlight is disabled</li></ul>	<i>4.5 d</i>
<i>No segments + blinking Err</i>	<ul style="list-style-type: none"><li>- change the battery!</li><li>- blinking battery symbol</li><li>- Dive Mode disabled</li><li>- returns to the Timekeeping display</li><li>- the backlight is disabled</li></ul>	<i>4.5 e</i>

Table 4.1 Battery Power Indicator.

NOTE: Low temperature or an internal oxidation of the battery may cause the battery warning (blinking Err) even though the battery has enough capacity. In this case repeat the battery check procedure by reactivating the Dive Mode.



In the Dive Mode the Low Battery Warning is indicated by the battery symbol.

If the battery symbol is displayed in the Surface Mode (Fig. 4.8) or if the display is faded or weak, it indicates that the battery power is low, and battery replacement is recommended.

NOTE: For safety reasons the backlight can not be activated during diving when the low battery warning is indicated by the battery symbol.

NOTE: Temperature affects the battery voltage. If the Spyder is stored at low temperatures (particularly below freezing point), the low battery warning may be displayed even though the battery has enough capacity in warmer conditions.

## 4.2.2 Dive Planning **PLAN**

It is possible at any time in the Surface Mode to enter the Planning Mode, simply by pressing the **(SELECT)** button. After showing the text PLAN and the mode indicator (Fig. 4.9), the display will show the no-decompression limit for the depth of 9 m

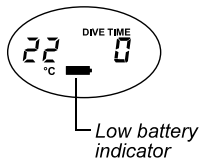

Fig. 4.8 Battery Warning. The battery symbol indicates that the battery power is getting low and battery replacement is recommended.

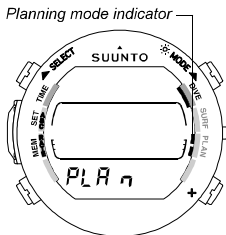

Fig. 4.9 Dive Planning. The Planning mode is indicated by the PLAN text and mode indicators.

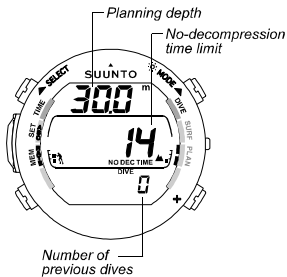

Fig. 4.10 Planning. The no-decompression time limit at 30.0 m [100 ft] is 14 minutes in P1/A0 mode.

[30 ft]. By pressing the  $\oplus$  button, the Spyder will calculate and show the next deeper no-decompression limits in 3 m [10 ft] increments ending at the depth where no-decompression time is 0 min or at 45 m [150 ft] (Fig 4.10). By pressing the  $\ominus$  button the next shallower depth will be shown again.

The Planning Mode can be canceled by pressing the  $\otimes$ MODE or the  $\textcircled{S}$ SELECT button.

NOTE: The Planning Mode is disabled if the Spyder has entered the Error Mode (See section 4.6, “Error Conditions”).

Higher Altitude or Personal Adjustment Modes will shorten the no-decompression time limits. These limits at different Altitude and Personal Adjustment Mode selections are shown in Table 8.1 and 8.2 in Section 8.1, “Operating Principles“.

The Spyder will also take into account the calculated residual nitrogen caused by your previous dives. The no-decompression times given for different depths will therefore be shorter than before your first dive.

## **Dive Numbering Shown During Dive Planning**

Several repetitive dives are considered to belong to the same repetitive dive series, if the Spyder still has been counting desaturation/no fly time. When the surface time is less than 10 minutes, the dives are considered to be one and the same. The dive number will not change for the second part of such a dive and the dive time will continue, where it left off.

### **4.2.3 Example Dive - For Easy Learning**

To allow you to get acquainted with the features and displays of the Spyder before diving, the example dive in figure 4.11 illustrates what the display would look like during an actual dive. The example dive shows a profile of a normal dive including no-decompression dive information.

### **4.2.4 Presetting Displays and Alarms**

The Spyder has a very unique (pat. pending) presetting system for the User Definable Display Field in the lower part of the display. You are also able to preset depth and time alarms according to your personal preference.

#### **Presetting the Displays**

The displays can be preset in the Surface Mode. If it is not active, enter it by selecting the Dive Mode.

Preset with the  button in the lower left corner of the display (Fig 4.12):

- the maximum depth or
- the temperature.

Fig. 4.11 An example dive profile.

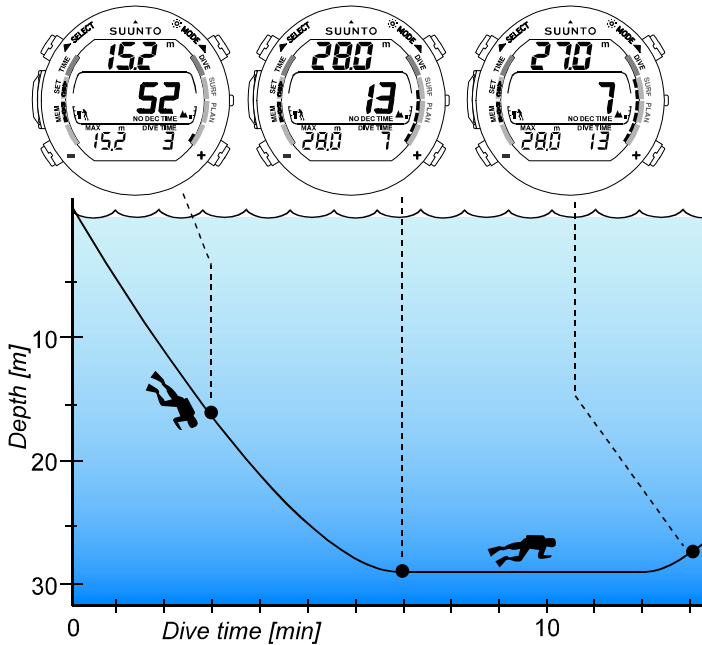

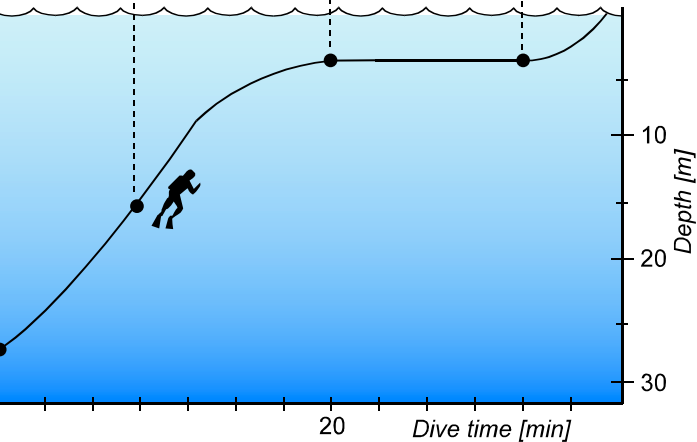
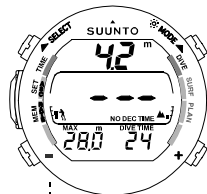
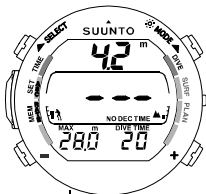
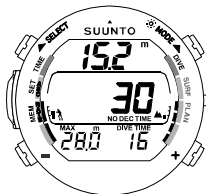

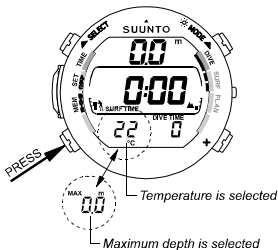

Fig. 4.12 The User Definable Display Field. Presetting the maximum depth or temperature display.

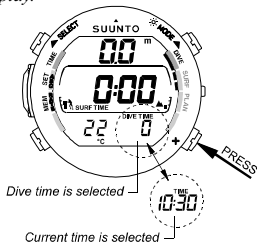

Fig 4.13 The User Definable Display Field. Presetting the dive time or current time display.

Preset with the  $\oplus$  button in the lower right corner of the display (4.13):

- the dive time or
- the current time.

The preset display will remain active until another display is selected. The preset displays will be the default displays in the Diving Mode. The other available display can be accessed by pressing the  $\oplus$  or  $\ominus$  button. After five seconds the display changes back to the default preset display automatically. It is, however, recommended that you avoid operating the push buttons underwater.

### Presetting Time and Depth Alarms

The alarm clock and the depth alarm are set in the Setting Mode. For further information see Section 5.2, “Daily Alarm Setting“ and 5.3, “Depth Alarm Setting “.

## 4.3 DIVING

### 4.3.1 Basic Dive Data

The Spyder will remain in the Surface Mode at depths less than 1.5 m [5 feet]. At depths greater than 1.5 m the Spyder will go into the Diving Mode.

All information on the display is labeled (Fig. 4.14). During a no-decompression dive, the following information will be shown:

- the available no-decompression time in minutes in the center window as NO DEC TIME and as a bar graph on the right side of the display. It is calculated based on the five factors listed in Section 8.1, “Operating Principles”.
- your present depth in meters [ft].
- the Altitude Adjustment setting on the right side of the center window with one to three bars and a mountain symbol (A0, A1, or A2).
- the Personal Adjustment setting on the left side of the center window with one to three bars and a diver symbol (P0, P1, or P2).

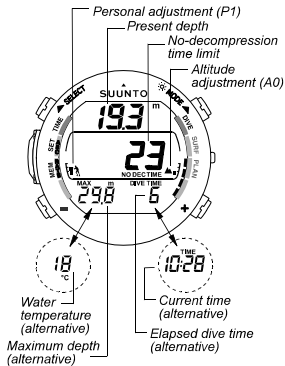

*Fig. 4.14 Diving display. The present depth is 19.3 m [63 ft] and the no-decompression time limit is 23 minutes in P1/A0 mode. The maximum depth during dive was 29.8 m [98 ft] and the elapsed dive time is 6 minutes. The alternative water temperature 18°C [64°F] or the current time 10:28 [10:28 am] are shown for 5 s after pressing the - or + buttons.*

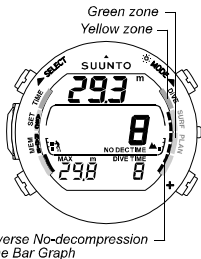

Fig. 4.15 Reverse no-decompression time bar graph. The lowest bar appears, when the available no-decompression time decreases below 60 minutes. The following bars appear, when the available no-decompression time decreases below 50, 40, 30, 20, 10 (green zone) and 5 minutes (yellow zone).

In the lower left corner one of the following will be shown according the presetting:

- the maximum depth during this dive in meters [ft], indicated as MAX or
- the water temperature, followed by °C for Centigrade [or ° F for Fahrenheit].

In the lower right corner one of the following information will be shown according the presetting:

- the elapsed dive time in minutes, shown as DIVE TIME or
- the current time, shown as TIME.

The other display can be activated by pressing the  $\oplus$  or  $\ominus$  button. After five seconds the display automatically changes back to the default preset display.

**CAUTION!** It is recommended that you avoid operating the push buttons underwater. Pushing the buttons underwater may cause a leak, which will seriously damage the unit.

### 4.3.2 Reverse No-decompression Time Bar Graph

The available no-decompression time is also shown visually in the multi-function bar graph on the right side of the display (Fig. 4.15). When



your available no-decompression time decreases below 60 minutes, the first (lowest) bar graph segment appears. As your body absorbs more nitrogen, more segments start to appear.

**Green Zone** - As a safety precaution SUUNTO recommends that divers using the Spyder should maintain the no-decompression bar graph within the green zone.

**Yellow Zone** - As all of the bars appear (yellow zone), your no-decompression limit is less than 5 minutes and you are getting very close to no-decompression limits. At this point, you should start your ascent towards the surface.

### 4.3.3 Ascent Rate Indicator

The ascent rate is shown graphically along the left side of the display, next to the notation ASC RATE, as follows:

<b>Ascent rate indicator</b>	<b>Ascent speed</b>	<b>Example in Fig.no.</b>
<i>No segments</i>	<i>Below 4 m/min [13 ft/min]</i>	<i>4.14</i>
<i>One segment</i>	<i>4 - 6 m/min [13 - 20 ft/min]</i>	<i>4.15</i>
<i>Two segments</i>	<i>6 - 8 m/min [20 - 26 ft/min]</i>	<i>4.16</i>
<i>Three segments</i>	<i>8 - 10 m/min [26 - 33 ft/min]</i>	<i>4.17</i>
<i>Four segments</i>	<i>Above 10 m/min [33 ft/min]</i>	<i>4.18</i>
<i>Four segments and Blinking SLOW</i>	<i>Above 10 m/min [33 ft/min]</i>	<i>4.18</i>

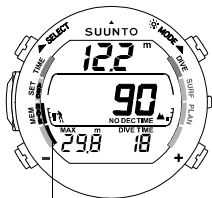

Ascent rate indicator

*Fig. 4.16 Ascent Rate Indicator. Two segments shown: ascent rate 6 - 8 m/min [20 - 26 ft/min].*

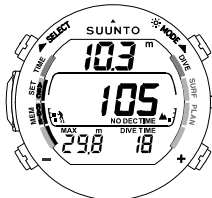

*Fig. 4.17 Ascent Rate Indicator. Three segments shown: ascent rate 8 - 10 m/min [26 - 33 ft/min].*

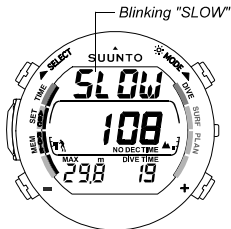

*Fig. 4.18 Ascent Rate Indicator. Blinking SLOW and four segments shown: ascent rate is more than 10 m/min [33 ft/min]. This is a caution to slow down!*

The SLOW warning alternates with the current depth. The SLOW warning is an indication that the maximum ascent rate has been exceeded continuously, whereas the ascent rate indicator shows present ascent speed.

Whenever the SLOW warning appears, you should immediately slow down or stop your ascent until the warning disappears. You must not ascend shallower than 3 m [10 ft] with the SLOW warning on. If you reach this depth with SLOW on, you must stop at this depth and wait until the warning disappears.

## **WARNING!**

DO NOT EXCEED THE MAXIMUM RECOMMENDED ASCENT RATE! Rapid ascents increase the risk of injury. You must never surface with the SLOW warning on. If you do this, the warning will continue to flash in the Surface Mode until the unit deactivates itself in a normal manner. This may take up to 48 hours.

## **WARNING!**

DO NOT ATTEMPT TO DIVE FOLLOWING A SURFACE INTERVAL DURING WHICH THE SLOW INDICATOR REMAINS ACTIVATED! Violation of the maximum ascent rate may invalidate the calculations for the next dive.

NOTE: SUUNTO highly recommends a safety stop at the end of every dive in the range of 3 m - 6 m [10 ft - 20 ft] for at least 3 - 5 minutes.

### **4.3.4 Audible and Visual Alarms**

The Spyder features audible and visual alarms to advise when important limits are approached or to acknowledge preset alarms set by the diver:

*Three single beeps with a two second interval, occur when:*

- the no-decompression dive turns into a decompression dive. An arrow pointing upwards and the ascent warning CEILING/ASC TIME will appear.

*Continuous beeps, occur when:*

- the maximum allowed ascent rate, 10 m/min [33 ft/min], is exceeded. A blinking SLOW warning will alternate with the depth display.

- the ceiling depth is exceeded. An error warning Er appears. You should immediately descend to or below the ceiling. The Spyder will otherwise enter a permanent Error Mode within three minutes, indicated by a permanent Er.

*User programmable alarms. The alarm activates when:*

- the preset alarm time is reached
  - continuous beep series for 24 s or until any button is pressed
  - 📍-symbol blinks for one minute, if no button is pressedor
- the preset depth is reached
  - continuous beep series for 24 s or until any button is pressed
  - 📏-symbol blinks as long as the present depth value exceeds the adjusted value.

NOTE: SUUNTO strongly recommends that sport divers limit their maximum depth to 40 m [130 ft]!

### 4.3.5 Decompression dives

#### **WARNING!**

DO NOT USE THIS INSTRUMENT TO CONDUCT DIVES WITH NECESSARY DECOMPRESSION STOPS! SUUNTO does not recommend this instrument to be used to conduct these types of dives. Decompression Diving limits the divers ability to ascend directly to the surface and may substantially increase the risk of decompression sickness.

However, if through carelessness or emergency a diver is forced to exceed the no-decompression limits on a dive, the Spyder will provide decompression informa-

tion required for ascent. After this the Spyder will continue to provide subsequent interval and repetitive dive information.

Rather than requiring you to make stops at fixed depths, the Spyder lets you to decompress within a range of depths (Continuous Decompression).

## **Background**

When your NO DEC TIME becomes zero, your dive becomes a decompression dive, i.e. you must perform one or several decompression stops on your way to the surface. The NO DEC TIME on your display will be replaced by a notation CEILING/ASC TIME.

### **WARNING!**

YOU SHOULD ASCEND AND BEGIN DECOMPRESSION IMMEDIATELY WHEN THE SPYDER SHOWS YOU THAT DECOMPRESSION IS REQUIRED! Note the upward pointing arrow.

The ascent time (ASC TIME) is the minimum amount of time needed to reach the surface in a decompression dive. It includes:

the time needed to ascend to the ceiling at an ascent rate of 10 m/min  
[33 ft/min]

plus

the time needed at the ceiling. The ceiling is the shallowest depth to which you should ascend

plus

the time needed to reach the surface after the ceiling has been removed.

## **WARNING!**

**YOUR ACTUAL ASCENT TIME MAY BE LONGER THAN DISPLAYED BY THE SPYDER.** The ascent time will increase if you:

- remain at depth
- ascend slower than 10 m/min [33 ft/min], or
- make your decompression stop deeper than at the ceiling.

These factors will also increase the amount of air required to reach the surface.

## **WARNING!**

**NEVER ASCEND ABOVE THE CEILING!** You must not ascend above the ceiling. In order to avoid doing so by accident, you should stay slightly below the ceiling.

### **Ceiling and Ceiling Zone**

When in decompression, it is important that you understand the meaning of ceiling and ceiling zone:

- The ceiling is the shallowest depth to which you should ascend when in decompression. At this depth, or below, you must perform one or several decompression stops. All decompression stops must be performed at or below the ceiling depth.
- The ceiling zone is the optimum decompression stop zone. It is the zone between the minimum ceiling and 1.8 m [6 ft] below the minimum ceiling.

The depth of the ceiling will depend on your dive profile. It will be fairly shallow when you enter the Decompression Mode, but if you remain at depth, the ceiling

will move downward and the ascent time will increase. Likewise, the ceiling may change while you are decompressing.

When the sea surface is rough, it may be difficult to maintain a constant depth near the surface. In this case it will be more manageable to maintain an additional distance below the ceiling, to make sure that the waves do not lift you above the ceiling. SUUNTO recommends that decompression takes place deeper than 4 m [13 ft], even if the indicated ceiling is shallower.

NOTE: It will take more time and more air to decompress below the ceiling than at the ceiling.

### Display below the Ceiling Zone

The CEILING/ASC TIME and upward pointing arrow indicate that you are below the ceiling zone (Fig. 4.19). You should start your ascent immediately.

The ceiling depth is shown on the left side of the center window and the minimum total ascent time on the right side of the center window.

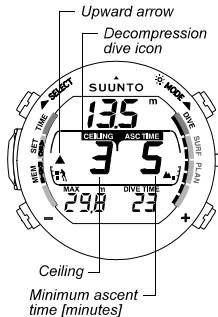

Fig. 4.19 Decompression dive, below the ceiling zone. The minimum ascent time is 5 minutes. The upward pointing arrow tells you to ascend. The ceiling is at 3 m [10 ft].

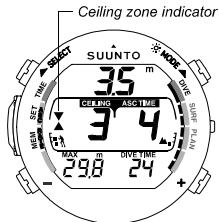

Fig. 4.20 Decompression dive, at the ceiling zone. The two arrows point at each other (“hour glass”). You are at the ceiling zone at 3.5 m [11 ft] and your minimum ascent time is 4 minutes.

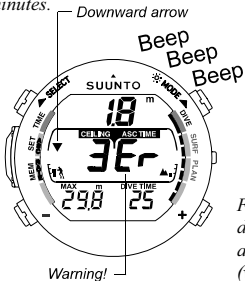

Fig. 4.21 Decompression dive, above ceiling. Note the downward pointing arrow and the Er warning. You will also hear an audible alarm. You should immediately (within 3 minutes) descend to or below the ceiling.

## Display at the Ceiling Zone

When you reach the ceiling zone, the display will show you two arrows pointing at each other (the “hourglass” icon, Fig 4.20). Do not ascend above this depth zone.

During decompression, ASC TIME will count down toward zero. When the ceiling moves upwards, you can ascent to the new ceiling. You may surface only when the ascent time reaches zero and the CEILING/ASC TIME is replaced by NO DEC TIME.

## Display above the Ceiling

If you ascend above the ceiling, a downward pointing arrow will appear and a continuous beeping starts (Fig. 4.21). In addition, an error warning Er reminds you that you have only three minutes to correct the situation. You must immediately descend to or below the ceiling.

If you continue to violate the decompression, the Spyder goes into a permanent Error Mode. In this



mode the Spyder can only be used as a depth gauge and timer. In the surface display the permanent Error Mode is indicated by a decompression dive icon (Fig. 4.22). You must not dive again for at least 48 hours. (See also section 4.6, “Error Conditions”.)

## 4.4 AT THE SURFACE

### 4.4.1 Surface Interval

An ascent to any depth shallower than 1.5 m [5 ft] will cause the DIVING display to be replaced by the SURFACE displays, giving the following information (Fig 4.23 and Fig 4.24).

- the surface time in hours and minutes (separated by a colon), telling the duration of the present surface interval. It is shown above SURF TIME in the center window of the display.
- the maximum depth in meters [ft] is shown in the same position as your depth readings during the dive. The MAX indicator is then shown in front of the value.
- the no-flying warning is indicated by an airplane icon with the surface time display.

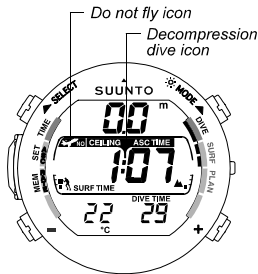

*Fig. 4.22 Surface Mode after a violated decompression dive. The CEILING/ASC TIME symbol indicates that you have violated the ceiling for more than three minutes. You must not dive again for at least 48 hours.*

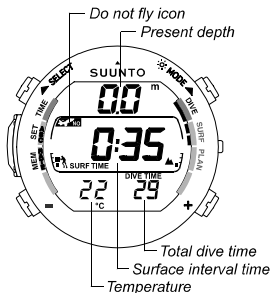

*Fig. 4.23 Surface interval, display I. You have surfaced 35 minutes ago from a 29 minute dive. The present depth is 0.0 m [0 ft]. The airplane symbol indicates that you should not fly. The temperature is 22°C [72°F].*

- the desaturation/no-flying time in hours and minutes is shown next to the airplane in the center window of the display.
- the present depth in meters [ft].
- the altitude adjustment setting.
- the personal adjustment setting.

In the lower left corner one of the following will be shown according to the presetting:

- the maximum depth of the most recent dive in meters [ft], indicated as MAX,
- the current temperature, followed by °C for Centigrade [or °F for Fahrenheit].

In the lower right corner one of the following will be shown according to the presetting:

- the dive time in minutes, i.e. the total duration of the most recent dive, shown as DIVE TIME,
- the current time, shown as TIME.

## Dive Numbering

Several repetitive dives are considered to belong to the same repetitive dive series when the Spyder has not counted the desaturation/no-fly time to zero. Within each series, the dives are given individual numbers. The first dive of the series will

be numbered as DIVE 1, the second as DIVE 2, the third as DIVE 3, etc.

If you start a new dive in less than 10 minutes at the surface, the Spyder interprets this as a continuation of the previous dive and the dives are considered to be one and the same. The diving display will return, the dive number will remain unchanged, and the dive time will begin where it left off. After 10 minutes on the surface, subsequent dives are by definition repetitive. The dive counter displayed in the Planning Mode will progress to the next higher number if another dive is made.

#### 4.4.2 Flying After Diving

The no-flying time is shown in the center window next to the airplane image. The airplane is a reminder, when the alternative display showing surface time is on (Figures 4.23 and 4.24). Flying or traveling to a higher altitude should be avoided at any time the airplane symbol is displayed.

The no-flying time displayed by the Spyder is always at least 12 hours or equivalent to the so-called desaturation time (if longer than 12 hours).

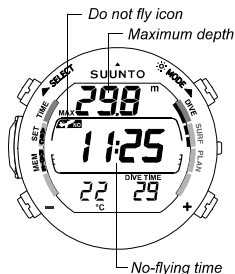

Fig 4.24 Surface interval, display II. The desaturation time/no-flying time, indicated by an airplane symbol, is 11 h 25 min. The maximum depth of the dive was 29.8 m [98 ft].

When this time has elapsed, the residual nitrogen is no longer a factor for subsequent dives.

In the permanent Error Mode the no-flying time is 48 hours.

Flying or traveling to a higher altitude after a dive may significantly increase the risk of decompression sickness.

### **WARNING!**

**YOU ARE ADVISED TO AVOID FLYING ANY TIME THE COMPUTER DISPLAYS THE DO NOT FLY WARNING, INDICATED BY AN AIRPLANE!**

Further, the Divers Alert Network (DAN) advises as follows:

- A minimum surface interval of 12 hours would be required in order to be reasonably assured a diver will remain symptom free upon ascent to altitude in a commercial jetliner (altitude up to 2400 m [8000 ft]).
- Divers who plan to make daily, multiple dives for several days, or make dives that require decompression stops, should take special precautions and wait for an extended interval beyond 12 hours before flight. Further, the Undersea and Hyperbaric Medical Society (UHMS) suggests divers using standard air tanks and exhibiting no symptoms of decompression sickness wait 24 hours after their last dive to fly in an aircraft with cabin pressure up to 2400 m [8000 ft]. The only two exceptions to this recommendation are:
  - If a diver had less than 2 hours total accumulated dive time in the last 48 hours, then a 12 hour surface interval before flying is recommended.
  - Following any dive that required a decompression stop, flying should be delayed for at least 24 hours, and if possible, for 48 hours.

SUUNTO recommends that flying be avoided until all the DAN and UHMS guidelines and the Spyder wait to fly conditions are satisfied.

### **WARNING!**

THERE CAN NEVER BE A FLYING AFTER DIVING RULE THAT IS GUARANTEED TO PREVENT DECOMPRESSION SICKNESS COMPLETELY!

## **4.5 HIGH ALTITUDE DIVES AND PERSONAL ADJUSTMENT**

The Spyder can be adjusted for increasing the conservatism of the mathematical nitrogen model and for diving at altitude.

### **WARNING!**

SET THE CORRECT ALTITUDE ADJUSTMENT MODE! When diving at altitudes greater than 700 m [2300 ft] the Altitude Adjustment feature must be correctly selected in order for the computer to calculate no-decompression status. Failure to properly select the Altitude Adjustment Mode correctly will result in erroneous data and can greatly increase the risk of DCS.

### **WARNING!**

THE SPYDER IS NOT INTENDED FOR USE AT ALTITUDES GREATER THAN 2400 m [8000 ft]! Diving at altitudes above this limit may significantly increase the risk of DCS.

Traveling to a higher elevation can temporarily cause a change in the equilibrium of dissolved nitrogen in the body with the surroundings. It is recommended that

the diver allow the body conditions to stabilize over a period of at least three hours before beginning to dive at altitude.

## WARNING!

SET THE CORRECT PERSONAL ADJUSTMENT MODE! The diver should use this option to make the calculations more conservative, whenever it is believed that factors which tend to increase the possibility of DCS exist. Failure to properly select the Personal Adjustment Mode correctly will result in erroneous data and can greatly increase the risk of DCS.

## ALTITUDE ADJUSTMENT

When programming the Spyder for the correct altitude, the diver needs to select the correct Altitude Mode according to Table 4.2 As a result the Spyder adjusts its mathematical model according to the entered altitude mode, giving shorter no-decompression times at higher altitudes (See Section 8.1, “Operating Principles“, Table 8.1. and 8.2.)



<b>Altitude mode</b>	<b>Symbol on display</b>	<b>Altitude range</b>
A0		0 - 700 m [0 - 2300 ft]
A1		700 - 1500 m [2300 - 5000 ft]
A2		1500 - 2400 m [5000 - 8000 ft]

Table 4.2 Altitude adjustment ranges.

The entered Altitude Adjustment Mode is indicated by a bar graph with one to three bars (A0, A1, or A2) and a mountain symbol. Section 5.4, “Altitude Adjustment and Personal Adjustment Setting“ describes how the Altitude Mode is adjusted.

## **Personal Adjustment**

Factors that may affect susceptibility to decompression sickness vary between divers and also for the same diver from one day to another. The three-step Personal Adjustment Mode is available to the user, if a more conservative dive plan is desired.

The factors, which tend to increase the possibility of DCS, include but are not limited to:

- cold exposure - water temperature less than 20 °C [68 °F]
- the diver is below average physical fitness level
- multiday or repetitive dive exposure
- diver fatigue
- diver dehydration
- previous history of DCS

The entered Personal Adjustment Mode is indicated by a bar graph with one to three bars (P0, P1, or P2) and a diver symbol. Section 5.4, “Altitude Adjustment and Personal Adjustment Setting“ describes how the Personal Mode is adjusted.

This feature should be used to adjust the computer more conservative according to personal preference by entering the suitable Personal Adjustment Mode with the help of Table 4.3. In ideal conditions, retain the default setting, P0. If conditions are more difficult or other mentioned factors exist, select P1 or even the most con-

servative P2. As a result the Spyder adjusts its mathematical model according to the entered Personal Adjustment Mode, giving shorter no-decompression times (See Section 8.1, “Operating Principles“, Table 8.1 and 8.2.)



<b>Personal mode</b>	<b>Symbol on display</b>	<b>Condition</b>	<b>Desired tables</b>
<i>P0</i>		<i>Ideal condition</i>	<i>Default</i>
<i>P1</i>		<i>Some mentioned factors or conditions exist</i>	<i>Progressively more conservative</i>
<i>P2</i>		<i>Several mentioned factors or conditions exist</i>	

Table 4. 3 Personal Adjustment ranges.

## **WARNING!**

THERE IS ALWAYS A RISK OF DECOMPRESSION SICKNESS FOR ANY DIVE PROFILE EVEN IF YOU FOLLOW THE DIVE PLAN PRESCRIBED BY DIVE TABLES OR A DIVE COMPUTER. You are advised to remain well within the exposure limits provided by the Spyder to minimize this risk. Decompression sickness can cause serious injury or death.



## 4.6 ERROR CONDITIONS

The Spyder is provided with warning indicators that advise the user to react to certain situations that would otherwise give rise to a significantly increased risk of DCS if left unattended. If you do not respond to its warnings, the Spyder will enter an Error Mode, indicating that the risk of DCS has greatly increased. If you understand and operate the Spyder sensibly, it is very unlikely you will ever put the Spyder into the Error Mode.

### **Omitted Decompression**

The Error Mode results from omitted decompression, when the diver stays above the ceiling for more than three minutes. During this three minute period the Er warning is shown and audible alarm beeps. After this the Spyder will enter a permanent Error Mode. The Spyder will continue to function normally if the diver descends below the ceiling within three minutes.

Once in the permanent Error Mode the Spyder will not show no-decompression or ascent times. Only a permanent Er warning is shown in the center window. However, all the other displays will function as before, to provide information for ascent. You should immediately ascend to a depth of 3 to 6 m [10 to 20 ft] and remain at this depth until air supply limitations require you to surface.

When the surface has been reached, no further diving should take place for a minimum of 48 hours. During the permanent Error Mode, the CEILING/ASC TIME symbol will be displayed in the center window and the Planning Mode cannot be entered.

## 5. SETTING MODE SET

The time and date, daily alarm, depth alarm and the altitude and personal adjustments are set in the Setting Mode (Fig. 5.1).

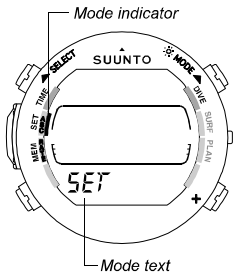

Fig. 5.2 The Setting Mode is indicated by the SET text and mode indicator.

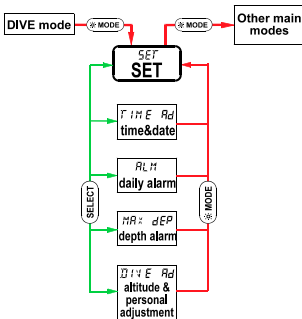

Fig. 5.1 Setting menu.

Enter the Setting Mode from other modes by pressing the **\*MODE** button. The text SET at the bottom and the mode indicator on the left side of the display indicate the selected mode (Fig. 5.2).

## 5.1 SETTING TIME AND DATE *TIME Ad*

To set the time and date:

1. In the Setting Mode, press **SELECT** to select the Time Adjustment Mode (Fig. 5.3).
2. Wait two seconds until the Time Adjustment Mode activates automatically. The time mode indicator appears and the second digits start to blink on the display (Fig. 5.4 a and b).
3. Press **SELECT** to change the selection in the following sequence:

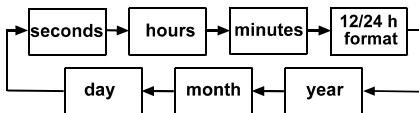

4. While the second digits are selected (blinking), press **-** to reset the seconds to “00” or press **+** to increase the value.
5. Set the other sections as follows:
  - While any other digits (except seconds) are selected (blinking), press **+** to increase the value or **-** to decrease it. Holding down either button starts to scroll the current selection.

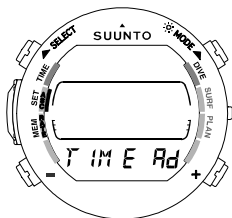

*Fig. 5.3 Time Adjustment Mode*

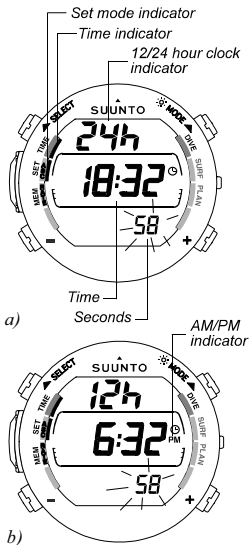

a)  
 b)  
 Fig. 5.4 The Time Adjustment Mode is activated and the second digits are blinking.

a) 24 hour clock  
 b) 12 hour clock

- While the 12/24 hour setting is selected, press  $\oplus$  or  $\ominus$  to switch between the two formats.
  - While year, month or day is selected, the display will show all the segments displayed in the Fig. 5.5.
6. After you have set the time and date, press the  $\text{[*MODE]}$  button to save the settings and to return to the Setting Mode (Fig. 5.2).

NOTE:

- The day of the week is automatically calculated in accordance with the date.
- The date can be set within the range of Jan 1, 1990 to Dec. 31, 2089.

NOTE:

- While the selection is blinking and no button is operated within 10 minutes, the blinking stops and the Spyder beeps and returns automatically to the timekeeping display.
- The display is illuminated by holding down the  $\text{[*MODE]}$  button for more than two seconds.

## 5.2 DAILY ALARM SETTING *ALM*

You can set one daily alarm in the Spyder. When the daily alarm activates, the 🛎 symbol blinks for 1 minute and the alarm sounds for 24 seconds. The alarm is given at the preset time each day. Press any button to stop the audible alarm, after it has activated.

To set the daily alarm:

1. In the Setting Mode, press **SELECT** two (2) times to select the Daily alarm Setting Mode (Fig. 5.6).
2. Wait two seconds until the Daily Alarm Setting Mode activates automatically. The time mode indicator appears and the alarm status [On/OFF] starts to blink on the display (Fig. 5.7). The alarm status [On/OFF] is blinking because it is selected.
3. Press **SELECT** to change the selection in the following sequence:

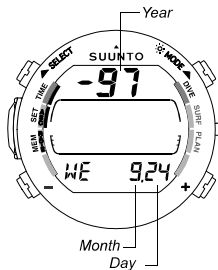

Fig. 5.5 The year, month or day is selected.

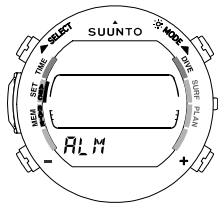

Fig. 5.6 Daily Alarm Setting Mode.

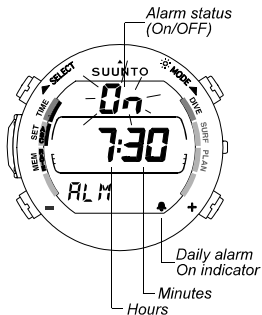

Fig. 5.7 Daily Alarm Setting Mode is activated

4. While the alarm status [On/OFF] is selected (blinking) press  $\oplus$  or  $\ominus$  to change the status. When the alarm status is On, the daily alarm indicator (🔔 symbol) in the bottom right corner of the display indicates that the alarm is on.
5. Set the other sections as follows:
  - While any other digits (except alarm status) are selected (blinking), press  $\oplus$  to increase the value or  $\ominus$  to decrease it. Holding down either button starts the scrolling of the current selection.
  - The 12-hour or 24-hour format of the alarm matches the format of the timekeeping display, which is selected in the Time Adjustment Mode (see section 5.1, “Setting Time and Date”). When using the 12-hour format of the alarm, take care to set the time correctly as morning (AM) or afternoon (PM).
6. After you have set the daily alarm, press the  $\text{MODE}$  button to save the settings and to return to the Setting Mode [SET] (Fig. 5.2).

## 5.3 DEPTH ALARM SETTING *MAX DEP*

You can set one depth alarm in the Spyder. When the depth alarm activates, the (■) symbol blinks as long as the present depth value exceeds the adjusted value and the alarm sounds for 24 seconds. Press any button to stop the audible alarm, after it has activated.

To set the depth alarm:

1. In the Setting Mode [SET], press (SELECT) three (3) times to select the Depth Alarm Setting Mode (Fig. 5.8).
2. Wait two seconds until the Depth Alarm Setting Mode activates automatically. The dive mode indicator appears and the alarm status [On/OFF] starts to blink on the display (Fig. 5.9). The alarm status [On/OFF] is blinking because it is selected.
3. Press (SELECT) to change the selection in the following sequence

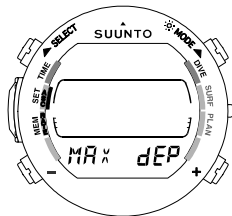
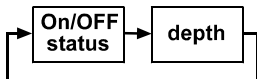

Fig. 5.8 Depth Alarm Setting Mode.

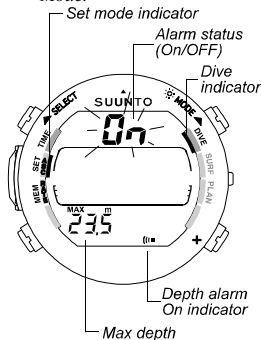

Fig. 5.9 Depth Alarm Setting Mode is activated.

4. While the alarm status [On/OFF] is selected (blinking), press **+** or **-** to change the status. When the alarm status is On, the depth alarm indicator (■ symbol) in the bottom right corner of the display indicates that the alarm is on.
5. While the depth digits are selected (blinking), press **+** to increase the value or **-** to decrease it at intervals of 0.5 m [1 ft]. Holding down either button starts the scrolling of the depth value. The range of the depth is from 3.0 to 96.0 m [10 to 315 ft].
6. After you have set the depth alarm, press the **MODE** button to save the settings and to return to the Setting Mode [SET] (Fig. 5.2).

## 5.4 ALTITUDE ADJUSTMENT AND PERSONAL ADJUSTMENT SETTING *DIVE Ad*

The current Altitude and Personal Adjustment Modes are shown when diving as well as at the surface. If the mode does not match the altitude or conditions (see Section 4.5.), it is imperative that the diver enters the correct selection before diving. Use the Altitude Adjustment to select the correct altitude mode. Use the Personal Adjustment to add an extra level of conservatism.

**NOTE: NEW ALTITUDE AND PERSONAL ADJUSTMENT SELECTIONS CANNOT BE MADE UNTIL 10 MINUTES AFTER THE DIVE.**

To set the new Altitude and Personal Adjustments:

1. In the Setting Mode [SET], press **SELECT** four (4) times to select the Dive Adjustment Mode (Fig. 5.10).



- Wait two seconds until the Dive Adjustment Mode activates automatically. The dive mode indicator appears and the altitude graph starts to blink on the display (Fig. 5.11). The altitude graph is blinking because it is selected.
- Press **SELECT** to change the selection in the following sequence

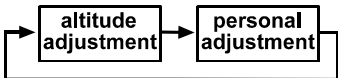

- While the altitude digits are selected (blinking), press **+** or **-** to change the Altitude Mode. The Altitude Mode alternatives are the following:

Altitude mode	Symbol on display	Altitude range
A0	▲■	0 - 700 m [0 - 2300 ft]
A1	▲■	700 - 1500 m [2300 - 5000 ft]
A2	▲■	1500 - 2400 m [5000 - 8000 ft]

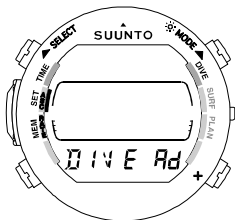

Fig. 5.10 Dive Adjustment Mode .

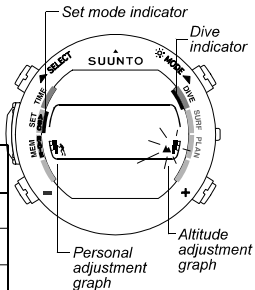





Fig. 5.11 Dive Adjustment Mode is activated.

5. While the personal adjustment digits are selected (blinking), press  $\oplus$  or  $\ominus$  to change the Personal Adjustment Mode. The Personal Adjustment Mode alternatives are the following:

<b>Personal mode</b>	<b>Symbol on display</b>	<b>Condition</b>	<b>Desired tables</b>
P0		<i>Ideal condition</i>	<i>Default</i>
P1		<i>Some physical, psychic or environmental factors or conditions exist (see chapter 4.5)</i>	<i>Progressively more conservative</i>
P2		<i>Several physical, psychic or environmental factors or conditions exist (see chapter 4.5)</i>	

6. After you have set the desired Altitude and Personal Adjustment Modes, press the  $\text{MODE}$  button to save the settings and to return to the Setting Mode [SET] (Fig. 5.2.).

## WARNING!

ALWAYS RECHECK THE PERSONAL AND ALTITUDE ADJUSTMENT TO ENSURE THAT THE ALTITUDE IS NOT SET FOR AN ALTITUDE LESS THAN THAT OF THE DIVE SITE AND THAT THE PERSONAL MODE CORRESPONDS TO THE DESIRED CONSERVATISM. Failure to enter this information could result in dive planning errors and risk exposure to decompression sickness.

## 6. MEMORIES AND DATA TRANSFER *MEM*

The memory functions for the Spyder include the combined Logbook and Dive Profile Memory, Dive History Memory and the PC-Interface functions (Fig. 6.1).

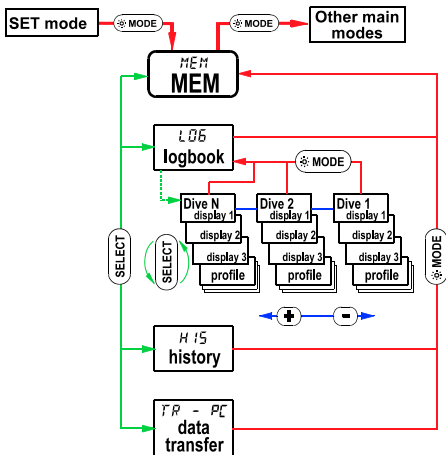

Fig. 6.1 The Memory menu.

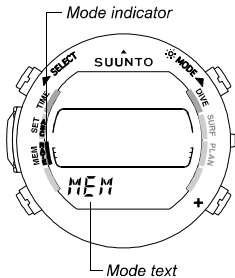

Fig. 6.2 Memory Mode is indicated by the MEM text and mode indicator.

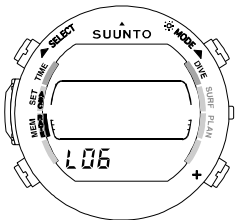

Fig. 6.3 Logbook Memory Mode.

NOTE: AFTER DIVING, THE MEMORY MODE CANNOT BE ACCESSED UNTIL 10 MINUTES AFTER THE DIVE.

Enter the Memory Mode [MEM] from other modes by pressing the **MODE** button. The text MEM at the bottom and the mode indicator on the left side of the display indicate the selected mode (Fig. 6.2).

If any button is not operated within 10 minutes after a function of the Memory Mode is selected, the Spyder beeps and returns to the timekeeping display automatically.

## 6.1 Logbook and Dive Profile

### Memory LOG

The Spyder has a very sophisticated high capacity Logbook and Profile Memory, with data being recorded every 20 seconds. Dives shorter than the recording interval are not registered.

The Logbook Memory will give access to approximately 36 hours of diving, starting with the most recent dive made.

To enter the Logbook Memory Mode:

1. In the Memory Mode [MEM], press **[SELECT]** to select the Logbook Memory Mode (Fig. 6.3). The LOG text appears at the bottom of the display to indicate the selected mode.
2. Wait two seconds until the Logbook Memory Mode activates automatically. The following information will be shown on three alternating displays (Fig. 6.4-6.6).

Press **[SELECT]** to switch the display between Logbook display I, II and III.

### **Display I, main display** (Fig. 6.4 a and b).

- maximum depth  
(NOTE: Due to lower resolution, the reading may differ from the maximum depth reading of the Dive History up to 0.3 m [1ft].)
- total dive time
- dive number
- altitude and personal adjustment settings
- a blinking SLOW if the diver has surfaced with the SLOW-warning on
- the CEILING ASC TIME -symbol, if the dive becomes a decompression dive
- **Er** in the center window, if the ceiling was violated.

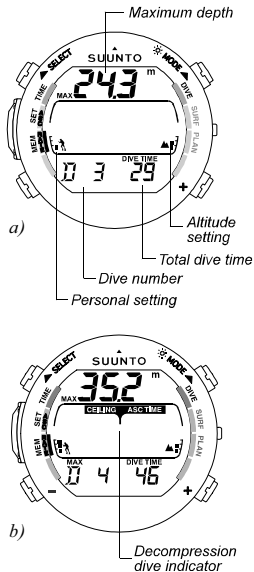

Fig. 6.4 Logbook, display I  
a) No-decompression dive  
b) Decompression dive

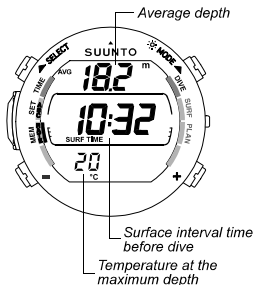

Fig. 6.5 Logbook, display II

### Display II (Fig. 6.5)

- average depth
- surface interval time before the dive
- temperature at the maximum depth

### Display III (Fig. 6.6)

- dive entry time and date

The data of the most recent dive is shown first. Press  $\ominus$  to call the previous dive. Press the  $\ominus$  button consecutively to move backward through the dives. When searching the dives, only Display I is shown. Press  $\oplus$  to move forward through the dives. The END text is displayed between the oldest and the most recent dive (Fig. 6.7).

The memory will always retain approximately the last 36 hours of dive time. After that, when new dives are recorded (after approximately 36 hours of diving), the oldest dives are deleted. The contents of the memory will remain even when the battery is changed (assuming that the replacement has been done according to the instructions).



Fig. 6.6 Logbook, display III

## Dive Profile Memory *PRO*

The detailed profile of the selected dive is accessed by pressing the **(SELECT)** button while the dive entry time and date (Display III), are shown on the display. The *PRO*-text at the bottom of the display indicates that the Spyder is now showing the profile of the selected dive.

The scrolling of the profile will start automatically when the Profile Memory Mode is entered (Fig. 6.8 a, b and c).

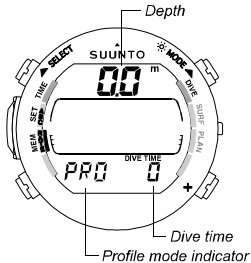
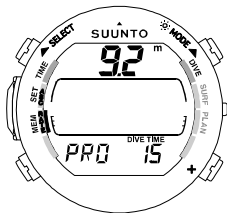

Fig. 6.8. Profile Memory

a) Start of the dive



b) During the dive

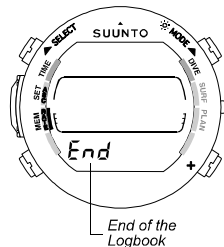
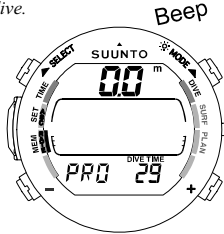

Fig. 6.7 In the Logbook, the *END* text is displayed between the oldest and the most recent dive.



c) End of the dive

The dive time is displayed in 20 second increments with each display being shown for about three seconds. The depths shown are the maximum values of each interval.

After the last depth figure of the selected profile ( Fig. 6.8), the Spyder automatically returns to Display I of the same dive in the Logbook. If desired, the profile of the same dive can be recalled again following the above procedure.

The scrolling of the profile can be stopped by pressing any button.

- Press **SELECT** to stop the scrolling and to return to Display I of the *same dive* in the Logbook.
- Press **+** to stop the scrolling and to change to Display I of the *next dive* in the Logbook.
- Press **-** to stop the scrolling and to change to Display I of the *previous dive* in the Logbook.
- Press **\*MODE** to stop the scrolling and to return to the beginning of the Logbook.
- Press **\*MODE** two (2) times to exit the Logbook Memory [LOG] and enter the Memory Mode [MEM].

NOTE: Several repetitive dives are considered to belong to the same repetitive dive series if the no-flying time has not ended. See “Dive Numbering” in section 4.4.1 for further information.



## 6.2 DIVE HISTORY MEMORY H 15

The Dive History is a summary of all the dives recorded by the Spyder. To enter the Dive History Memory Mode:

1. In the Memory Mode [MEM], press **SELECT** two (2) times to select the Dive History Memory Mode (Fig. 6.9). The HIS text appears at the bottom of the display to indicate the selected mode.
2. Wait two seconds until the Dive History Memory Mode activates automatically. The following information will be shown on the display (Fig. 6.10):

- the maximum depth ever reached
- the total accumulated dive time in hours
- the total number of dives.

999 dives and 999 hours of diving can be registered. When these maximum values are reached, the counters will start again from 0.

NOTE: The maximum depth can be reset to 0.0 m [0 ft] using the optional SUUNTO ACW PC-Interface (see the SUUNTO ACW Divelog for Windows manual).

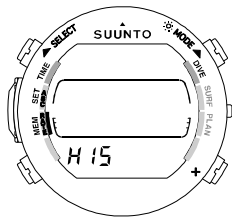

Fig. 6.9 Dive History Memory Mode.

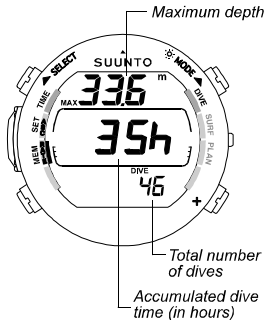

Fig. 6.10 Dive History Memory.

## 6.3 DATA TRANSFER AND PC-INTERFACE *TR - PC*

The Spyder can be connected to an IBM compatible personal computer (PC), using the optional SUUNTO ACW PC-Interface and its software. With the PC-Interface dive data from the Spyder can be downloaded to a PC. The PC-Interface software can be used for educational and demonstration purposes, for planning dives, as well as for keeping complete record of your dive history with the Spyder. Complete Logbook data can also be included. Paper copies of your dive log and profiles can then easily be printed.

The data transfer is carried out using the water contact of the Spyder. The following data is transferred to the PC:

- depth profile of the dive
- dive time
- dive number
- altitude and personal adjustment settings
- temperature at maximum depth
- surface interval time
- dive entry time (year, month, day and time)
- additional dive information (e.g. violations)
- identity number

It is also possible to manually add comments and other personal information to the PC based dive data files. The SUUNTO ACW PC-Interface package comes complete with the interface unit, the software on 3.5" disks, and a complete instruction manual.

To enter the Data Transfer Mode:

1. In the Memory Mode [MEM], press **SELECT** three (3) times to select the Data Transfer Mode (Fig. 6.11). The TR-PC text appears at the bottom of the display to indicate the selected mode.
2. The Data Transfer Mode activates automatically when the Spyder is placed in the interface unit.

**NOTE:** While in the Data Transfer Mode, the water contact is used only for the data transfer, and when connecting the contact by submerging it, the Dive Mode IS NOT automatically activated. Data transfer stops also the stopwatch.

After you have finished the data transfer, Press the **MODE** to exit Data Transfer Mode [TR-PC] and enter the Memory Mode [MEM]. If no button is operated or no data is transferred within 10 minutes, the Spyder beeps and returns to the time-keeping display automatically.

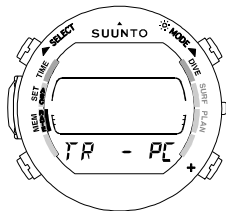

*Fig. 6.11 Data Transfer Mode.*

## **7. CARE AND MAINTENANCE**

The SUUNTO Spyder Advanced Computer Watch is a sophisticated precision instrument. Remember to treat it as such. It has been designed to withstand the rigors of scuba diving.

### **7.1 CARE OF YOUR ADVANCED COMPUTER WATCH**

- NEVER try to open the case of the Spyder or remove the buttons.
- NEVER try to open the depth sensor cover yourself.
- Service your Spyder every two years or after 200 dives (whichever comes first) by an authorized dealer or distributor. This service will include a general operational check, replacement of the seals, buttons and battery, and a water resistance check. The service requires special tools and training. Therefore, it is advisable to contact an authorized SUUNTO dealer or distributor for biennial service. Do not attempt to do any service that you are not sure about how to do.
- Should moisture appear inside the Spyder have it checked immediately by your SUUNTO dealer or distributor.
- Should you detect scratches, cracks or other such flaws on the mineral crystal of the display that may impair its durability, have it replaced immediately by your SUUNTO dealer or distributor.
- Check the spring bars holding the strap and the buckle for flaws. If the flexibility of the spring bars has reduced, have them replaced immediately by your SUUNTO dealer or distributor
- Wash and rinse the unit in fresh water after every use.
- Protect the unit from shocks, extreme heat or direct sunlight and chemical at-

tack. The Spyder cannot withstand the impact of heavy objects like scuba cylinders, nor chemicals like gasoline, cleaning solvents, aerosol sprays, adhesive agents, paint, acetone, alcohol etc. Chemical reactions with such agents will damage seals, case and finish.

- Store your Spyder in a dry place when you are not using it.
- The Spyder will display a battery symbol as a warning when the power gets too low. When this happens, the Spyder should not be used until the battery has been replaced by an authorized SUUNTO dealer or distributor (see also section 4.2.1, “Activation, Prechecks and Battery Warning“).
- Do not fasten the strap of your Spyder too tightly. You should be able to insert your finger between the strap and your wrist. Use extension strap when fastening the Spyder on your exposure suit.

## **7.2 MAINTENANCE**

If left without care for an extended period, a thin film (often invisible to the eye) will cover the unit. Much like the buildup on the glass of an aquarium, this film is the result of organic contaminants found in both salt and fresh water. Suntan oil, silicone spray and grease will speed up this process. As a result of this buildup, moisture will be trapped next to the water contact and will not allow your Spyder to operate properly.

The water contact can be cleaned with a soft pencil eraser.

**IMPORTANT:** The Spyder should be soaked, then thoroughly rinsed with fresh water and then dried with a soft towel after each dive. Make sure that all salt crystals and sand particles have been flushed out. Check the mineral crystal for

possible moisture or water. DO NOT use the Spyder if you detect any moisture or water inside.

## **CAUTION!**

- do not use compressed air to blow water off the unit
- do not use solvents or other cleaning fluids that might cause damage
- do not test or use the Spyder in pressurized air.

## **7.3 WATER RESISTANCE INSPECTION**

Water resistance of the unit must be checked after replacement of the battery, mineral crystal or buttons. The check requires special equipment and training.

You must frequently check the mineral crystal for leaks. If you find moisture inside your advanced computer watch, there is a leak. A leak must be corrected without delay, as moisture will seriously damage the unit, even beyond repair. SUUNTO does not take any responsibility for damage caused by moisture in the advanced computer watch, if the instructions of this manual are not carefully followed.

In case of a leak immediately bring the Spyder to an authorized SUUNTO dealer or distributor.

## **8. TECHNICAL DESCRIPTION**

### **8.1 OPERATING PRINCIPLES**

The SUUNTO Spyder is a multi-functional sport diving instrument, which provides information on depths, times, and decompression requirements. Its elec-

tronic microprocessor mathematically models the absorption and release of nitrogen during all phases of diving, including ascents, surface intervals and repetitive dives.

## No-Decompression Limits

The no-decompression limits for the first dive of the series displayed by the Spyder are for most dives to a single depth slightly more conservative than those permitted by the U.S. Navy tables, see Table 8.1 and 8.2.

























Depth [m]	Personal Mode / Altitude Mode								
	P0/A0  	P0/A1   	P0/A2   	P1/A0  	P1/A1   	P1/A2   	P2/A0  	P2/A1   	P2/A2   
9	---	160	130	160	130	96	130	96	75
12	125	89	67	89	67	54	67	54	45
15	72	57	43	57	43	35	43	35	29
18	52	39	30	39	30	25	30	25	21
21	38	30	24	30	24	21	24	21	15
24	29	23	19	23	19	15	19	15	12
27	23	19	15	19	15	12	15	12	9
30	18	14	12	14	12	9	12	9	7
33	13	11	9	11	9	8	9	8	6
36	11	9	8	9	8	6	8	6	5
39	9	7	6	7	6	5	6	5	4
42	7	6	5	6	5	5	5	5	4
45	6	5	5	5	5	4	5	4	3

Table 8.1 No-decompression time limits (min) for various depths [m] for the first dive of a series.

























Depth [ft]	Personal Mode / Altitude Mode								
	P0/A0  	P0/A1   	P0/A2   	P1/A0  	P1/A1   	P1/A2   	P2/A0  	P2/A1   	P2/A2   
30	195	156	127	156	127	93	127	93	73
40	120	86	65	86	65	53	65	53	43
50	69	56	41	56	41	34	41	34	28
60	51	38	29	38	29	25	29	25	20
70	35	28	22	28	22	19	22	19	14
80	28	23	19	23	19	15	19	15	11
90	21	18	15	18	15	11	15	11	9
100	17	14	11	14	11	9	11	9	7
110	13	11	9	11	9	7	9	7	6
120	10	9	8	9	8	6	8	6	5
130	9	7	6	7	6	5	6	5	4
140	7	6	5	6	5	4	5	4	3
150	5	5	4	5	4	4	4	4	3

Table 8.2 No-decompression time limits (min) for various depths [ft] for the first dive of a series.

Unlike the U.S. Navy tables, the Spyder interpolates between depths, giving a diver “credit” for time spent in shallower water, rather than calculating no-decompression limits based on the maximum depth of a dive. As a result, no-decompression dive times permitted by the Spyder are often much longer than those that would be allowed by the U.S. Navy tables.



## **WARNING!**

THE USER SHOULD BE AWARE THAT ANY DIVE, INCLUDING ONES WITHIN THE U.S. NAVY OR SPYDER LIMITS, DOES CARRY SOME RISK OF DECOMPRESSION SICKNESS.

### **Compartments and Half Times**

When you dive with the Spyder, it measures and displays depths and times as your dive progresses. It shows you available no-decompression time and possible decompression required based upon the following five factors:

1. your present depth,
2. excess nitrogen absorbed during earlier portions of the dive,
3. residual nitrogen remaining from previous dives,
4. the no-decompression limits that apply to that depth,
5. the Altitude and Personal Adjustment Modes in use.

Back on the surface, the Spyder will continue to calculate the no-decompression dive times available for various depths on the next dive. As the surface interval increases, so does the available dive time for the next dive.

To perform these calculations, the Spyder continuously models the absorption and release of excess nitrogen from theoretical compartments. Each compartment absorbs and releases nitrogen at a different rate. The compartments that absorb and release nitrogen rapidly are believed to have a high tolerance for excess nitrogen, whereas compartments that absorb and release nitrogen more slowly are believed to be more sensitive.

The no-decompression limits in the U.S. Navy tables are based upon six theoretical compartments for single dives, and one compartment for surface intervals and repetitive dives. If you are familiar with table theory, you may know that they are characterized by half times (i.e. the time required for 50 % equilibration to a pressure change) ranging from 5 minutes to 120 minutes.

The Spyder includes the same six compartments, and three additional compartments for an increased range of the mathematical model. The calculations are based on all nine compartments for all phases of diving, including surface intervals and repetitive dives. The Spyder's half times range from 2.5 to 480 minutes.

### **Altitude Diving**

The atmospheric pressure is lower at high altitudes than at sea level. After traveling to a higher altitude, the diver will have additional nitrogen in his body, compared to the equilibrium situation at the original altitude. This “additional” nitrogen is released gradually in time and equilibrium is reached within a couple of days. Do not dive until the equilibrium is reached.

Before high altitude diving the Spyder must be set to the high altitude diving mode to adjust the calculations for the new altitude. The maximum partial pressures of nitrogen allowed by the mathematical model of the Spyder are reduced according to the lower ambient pressure.

As a result the allowed no-decompression limits are considerably reduced.

### **Surface Intervals**

The Spyder requires a minimum surface interval of 10 minutes between dives. If a surface interval is shorter than 10 minutes, the Spyder dive counter and dive timer

treat the next dive as a continuation of the previous dive. It adds the dive times, and calculates no-decompression limits or decompression stops based on excess nitrogen absorbed on both dives. In this regard, it is similar to the U.S. Navy tables.

## **Depth Limits**

### **WARNING!**

SUUNTO STRONGLY RECOMMENDS THAT SPORT DIVERS LIMIT THEIR MAXIMUM DEPTH TO 40 m [130 ft]! Exposure to greater depth increases the risk of decompression sickness.

However, the Spyder will calculate at greater depths to provide a wide margin of flexibility if, through carelessness or emergency, you exceed this recommended depth limit for a dive.

## 8.2 TECHNICAL SPECIFICATION

### Dimensions and weight:

- Diameter: 46 mm [1.81 in]
- Thickness: 15 mm [0.59 in]
- Weight: 105 g [3.7 oz] (with elastomer strap)

### Depth Gauge:

- Temperature compensated pressure sensor
- Salt water calibrated (in fresh water the readings are about 3% smaller)
- Depth display range: 0 ... 99 m [325 ft]
- Accuracy:  $\pm 1\%$  Full Scale (0 to 60 m [200 ft] at 20 °C [68 °F])
- Resolution: 0.1 m [1 ft]

### Temperature display:

- Resolution: 1 °C [1.5 °F]
- Display range: -20 ... +50 °C [-4 ... +122 °F]
- Accuracy:  $\pm 2\text{ °C}$  [ $\pm 3.6\text{ °F}$ ] within 20 minutes of temperature change

### Calendar Clock:

- Accuracy:  $\pm 15\text{ s/month}$  (at 20 °C [68 °F])
- 12/24 h display

### Other displays:

- Dive time: 0 to 999 min
- Surface time: 0 to 48 h
- Dive counter: 0 to 99
- No-decompression time: 0 to 199 min (- - - after 199)

- Ascent time: 0 to 99 min (- - after 99)
- Ceiling depths: 3 to 30 m [10 to 99 ft] (- - after 30 m [99 ft])

### **Logbook/Dive Profile Memory:**

- Recording interval: 20 s
- Memory capacity: approximately 36 hours of diving
- Depth resolution: 0.3 m [1 ft]

### **Operating Conditions**

- Normal altitude range: 0 to 2400 m [8000 ft] above sea level
- Operating temperature: 0 to 40°C [32°F to 104°F]
- Storage temperature: -20°C to +50°C [-4°F to +122°F]

However, it is recommended that the unit be stored in a dry place at room temperature.

NOTE: Do not leave the Spyder in direct sunlight!

### **Battery**

- One 3 V lithium battery; CR 2430 + O-ring 38.50 mm x 1.00 mm 70 ShA
- Battery life: typically from 80 to 300 dives depending on the length of the dives, the use of the backlight and audible Alarms. Maximum lifetime of the battery, if used only as a watch, is approx. 1.5 years (at 20°C [68°F]).

## 9. WARRANTY

NOTE: The warranty arrangements are different in different countries. The Spyder packaging contains information regarding the warranty benefits and requirements applicable to your purchase.

The SUUNTO Spyder is warranted against defects in workmanship and materials for a period of two years after purchase to the original owner subject to and in accordance with the terms and conditions set forth below:

The Spyder should be serviced or repaired only by an authorized SUUNTO dealer or distributor. Each service or repair activity should be marked in the Service Card at the end of this manual.

This warranty does not cover damage to the product resulting from improper usage, improper maintenance, neglect of care, alteration or unauthorized repair. This warranty will automatically become void if proper preventive maintenance procedures have not been followed as outlined in the use and care instructions for this product.

If a claim under this or any other warranty appears to be necessary, return the product, freight prepaid, to your SUUNTO dealer or distributor or qualified repair facility. Include your name and address, proof of purchase and/or service registration card, as required in your country. The claim will be honored and the product repaired or replaced at no charge and returned in what your SUUNTO dealer or distributor determines a reasonable amount of time, provided all necessary parts are in stock. All repairs made, not covered under the terms of this warranty, will be

made at the owner's expense. This warranty is non-transferable from the original owner.

All implied warranties, including but not limited to the implied warranties of merchantability and fitness for a particular purpose, are limited from date of purchase and in scope to the warranties expressed herein. SUUNTO shall not be liable for loss of use of the product or other incidental or consequential costs, expenses or damage incurred by the purchase. All warranties not stated herein are expressly disclaimed.

Some states do not allow the exclusion or limitation of implied warranties of consequential damages, so the above exclusions or limitations may not apply to you. This warranty gives you specific legal rights, and you may also have other rights that vary from state to state.

This warranty does not cover any representation or warranty made by dealers or representatives beyond the provisions of this warranty. No dealer or representation is authorized to make any modifications to this warranty or to make any additional warranty.

Battery replacement is not covered by this warranty.

This Instruction Manual should be kept with your Spyder.

## 10. GLOSSARY

Altitude dive	A dive made at an elevation greater than 700 m [2300 ft] above sea-level.
Ascent rate	The speed at which the diver ascends toward the surface.
ASC RATE	Abbreviation for ascent rate.
Ascent time	The minimum amount of time needed to reach the surface on a decompression dive.
ASC TIME	Abbreviation for ascent time.
Ceiling	On a decompression dive the shallowest depth to which a diver may ascend based on computer nitrogen load.
Ceiling Zone	On a decompression dive the zone between the ceiling and the ceiling plus 1.8 m [6 ft]. This depth range is displayed with the two arrows pointing toward each other (the “hourglass“ icon).
Compartment	See “Tissue group”.
DCS	Abbreviation for decompression sickness.
Decompression sickness	Any of a variety of maladies resulting either primarily or secondary from the formation of nitrogen bubbles in tissues or body fluids, as a result of inadequately controlled decompression. Commonly called “bends” or “DCS”.



Dive series	A group of repetitive dives between which the Spyder indicates some nitrogen loading is present.
Dive time	Elapsed time between leaving the surface to descend, and returning to the surface at the end of a dive.
Half-time	After a change in ambient pressure, the amount of time required for the partial pressure of nitrogen in a theoretical compartment to go half-way from its previous value to saturation at the new ambient pressure.
Multi-level dive	A single or repetitive dive that includes time spent at various depths and whose no-decompression limits are not determined solely by the maximum depth attained.
No-decompression time	The maximum amount of time a diver may remain at a particular depth without having to make decompression stops or remain below a ceiling during the subsequent ascent.
No-decompression dive	Any dive which permits a direct, uninterrupted ascent to the surface at any time.
NODEC TIME	Abbreviation for no-decompression time limit.
Repetitive dive	Any dive whose no-decompression time limits are affected by residual nitrogen absorbed during previous dives.

Residual nitrogen

The amount of excess nitrogen remaining in a diver after one or more dives.

SURF TIME

Abbreviation for surface interval time.

Surface interval time

Elapsed time between surfacing from a dive and beginning a descent for the subsequent repetitive dive.

Tissue group

Theoretical concept used to model bodily tissues for the construction of decompression tables or calculations.



Move from one mode to another with **MODE** button.

**TIME** --> automatically to time keeping

or **+** select display field: date/seconds

**-**

**SELECT** to the stopwatch --> **TIME**

**stopwatch**

Elapsed time  
measurement

Split time  
measurement

**+** Start

**+** Start

**+** Stop

**-** Split

**+** Restart

**-** Split release

**+** Stop

**+** Stop

**-** Clear

**-** Clear

**MODE** return from stopwatch  
to the time keeping

**DIVE** --> automatically to **SUR F**

**Surface**

**+** preset display: dive time/current time

**-** preset display: max depth/temperature

**SELECT** to planning --> **PL R n**

**+** deeper no decompression limits

**-** shallower no decompression limits

**MODE** or **SELECT** return to the surface display

**Diving**

**+** select display field: dive time/current time

**-** select display field: max depth/temp.

**SET**

1 x **SELECT** time and date **TIME Ad**

2 x **SELECT** daily alarm **ALM**

3 x **SELECT** depth alarm **MR: dEP**

4 x **SELECT** altitude & pers. adjust. **DIVE Ad**

The use of the buttons within setting modes:

**SELECT** change the selection

**+** or **-** **TIME Ad** : change 12/24 h  
**ALM, MR: dEP** : change ON/OFF

**+** increase the value

**-** decrease the value

**TIME Ad** : reset seconds to '00'

**MODE** return to **SET**

**MEM**

1 x **SELECT** logbook **LOG**

**SELECT** switch between displays I, II and III

**-** move backwards **+** move forward

display III: press **SELECT** to enter profile **PRO**

profile: press **SELECT**, **+** or **-** to move

to display I of the same, next or previous dive,

press **MODE** to move to the most recent dive

**MODE** return from logbook to **MEM**

2 x **SELECT** history --> **HIS**

**MODE** return from history to **MEM**

3 x **SELECT** data transfer

**MODE** return from data transfer to **MEM**



# SUUNTO

Juvan teollisuuskatu 8  
FIN-02920 Espoo, Finland  
Tel. +358 9 8524 050  
Fax +358 9 8524 267  
[www.suunto.com](http://www.suunto.com)